

Exterior Building Materials and Colors

1. Brick with concave gray mortar joints
2. Fiber cement panels
3. Metal trim at fiber cement panels
4. Stone cap on front entry brick wing walls
5. Front entry metal guard and handrail
6. Aluminum gutters and downspouts
7. Windows: Pella Lifestyle Series wood / aluminum clad color: Wolf Gray
8. Front entry and ADA door: hollow metal with windows
9. Aluminum sectional garage door with windows: 16' wide x 8' high
10. Front entry metal suspended canopy with tension rods,
11. Rear bedroom metal suspended balcony with tension rods,
12. Roof parapet down lighting, brick wash over front entry:

Exterior Site Materials

- A. Front entry light wall mount
- B. Front entry lighted address plate
- C. Area light above garages and on building elevation along alley
- D. Brick wall wash LED lights between bays within roof parapet cap
- E. Metal car port



Badlands Smooth

Contains Recycled Content

 Save Product Compare Brick

 [Where To Buy](#) [Contact Us](#)



[See this on your house](#)

[Download seamless tileable image](#)

Product Information:

Type: Facebrick

Color: Tan

Style: Extruded

Plant: Sergeant Bluff

Series: Cosmopolitan Series

Texture/Finish: Smooth

Sizes

Technical Information

General Availability	T	H	L		Brick per sq ft
Modular	3-5/8	2-1/4	7-5/8	in.	6.86
Utility	3-5/8	3-5/8	11-5/8	in.	3.00
Norman	3-5/8	2-1/4	11-5/8	in.	4.57

You May Also Like

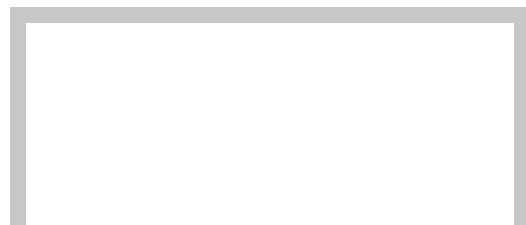
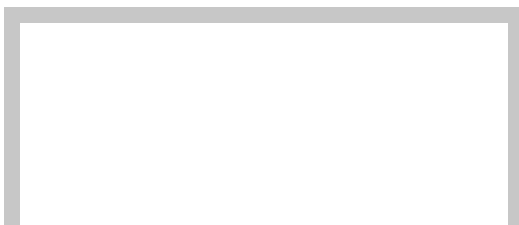



[Home](#) > James Hardie Panel Fiber Cement Siding Statement Collection

James Hardie Panel Fiber Cement Smooth Siding 48"x120" Pearl Gray 1pc



[Be the first to review this product](#)

\$130.18

Color *

Pearl Gray ▼

Texture *

Smooth ▼

Qty

1

Add to Cart

[Add to Compare](#)

*This is a special order product- subject to return restrictions. [Shipping and return policy](#)

This product is rated **HardieZone 5 (HZ5)**.

HZ5 materials are approved in HZ5 & HZ10 weather zones.

James Hardie HardiePanel Fiber Cement Smooth Siding 48"x120" Pearl Gray 1pc

You can't go wrong with this sleek, modern siding by industry leader James Hardie. Combine with HardieTrim boards for a rustic board-and-batten look. Or, go for the more minimalist look of simple vertical lines. Installed on over 8 million homes from coast to coast, James Hardie's fiber cement siding products are designed to resist the most extreme conditions while delivering long-term beauty and lower maintenance. We use the highest quality raw materials and proprietary additives for enhanced strength and moisture protection. Baked-on color delivers a beautiful finish that resists fading and makes a lasting impression.

Thickness: 0.31" Width: 48" Length: 10'

*Despite every effort to provide accurate images of each product, color may vary slightly due to photographic lighting sources or your monitor settings.

For colors or types of Hardie siding not included with this order, see "Related Products" below or use search feature.

Details

Description

James Hardie HardiePanel Fiber Cement Smooth Siding 48"x120" Pearl Gray 1pc Re-siding your house with HardiePanel Fiber Cement vertical siding is sure to add visual punch to your design.

Warranty:

The warranty will be honored only through the manufacturer, James Hardie. For your convenience, product warranty information is attached below; please click the link to view the current warranty policy on the manufacturer's site. If you need further assistance regarding your coverage or have other inquiries, please contact the manufacturer directly.

[James Hardie Warranty Information](#)

Reviews

Related Products

Check items to add to the cart or

[select all](#)



THE EASY CHOICE

Bold Design. Superior Functionality.

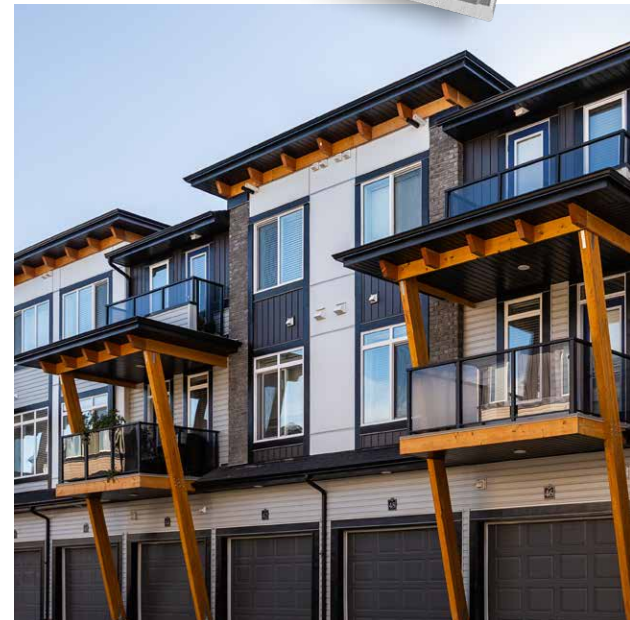
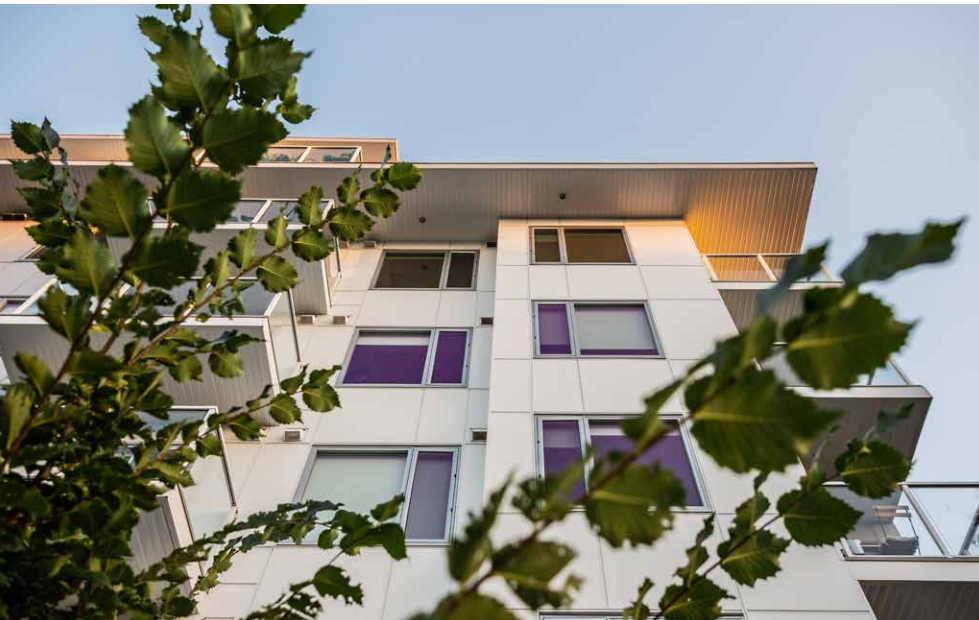

EasyTrim Reveals® is a complete two-piece, exterior aluminum trim system compatible with the most popular lap, siding and panel options on the market. EasyTrim Reveals® is the go-to for both residential and commercial projects across North America.

- ➔ UV / Fade Resistant
- ➔ Full-Edge Protection
- ➔ Anti-Corrosive
- ➔ Maintenance Free
- ➔ Moisture Management
- ➔ No-Sharp Edges



The Easiest Choice to Make

More than just a trim solution, EasyTrim Reveals® significantly reduces installation time and enhances the building's exterior performance, minimizing the need for ongoing maintenance. Our Fit and Finish™ system features overlapping trims that protect siding from moisture and harsh elements. This design not only preserves the aesthetics but also extends the life of your building exterior, making EasyTrim Reveals® the smart choice for long-lasting quality.



Multiple Colors and Finishes to Choose from

Full selection of color options available on our website.



Visit our website to engage with a representative or to find out more about our two-piece trim system:



+1 877 973 8746
info@engagebp.com
engagebp.com/easytrim

ENGAGE
BUILDING PRODUCTS™

Powder Perfect
Exteriors

INDIANA LIMESTONE - STANDARD GRAY™

4.



● LIMESTONE



HONED

DESCRIPTION

This neutral limestone possesses a subdued palette featuring light to medium shades of gray. A restrained, underlying vein pattern and subtle grain movement are visible in the fine to medium grained surface.

QUARRY OPERATING SINCE

1897

ANNUAL PRODUCTION

12 000 m³ and more
(423 776 cu. ft.)

AVAILABLE FINISHES

Honed	Bush-Hammered	Split Face
Sandblasted	Wire Brushed	Tumbled

APPLICATIONS

Exterior	Vertical
Interior	Commercial
Horizontal	Residential

PHYSICAL TEST RESULTS

		Imperial	Metric
Absorption by weight	ASTM C97	7.5%	7.5%
Density	ASTM C97	144 lb/ft ³	2 306.66 kg/m ³
Compressive strength	ASTM C170	4 000 Psi	27.58 MPa
Modulus of rupture	ASTM C99	700 Psi	4.83 MPa

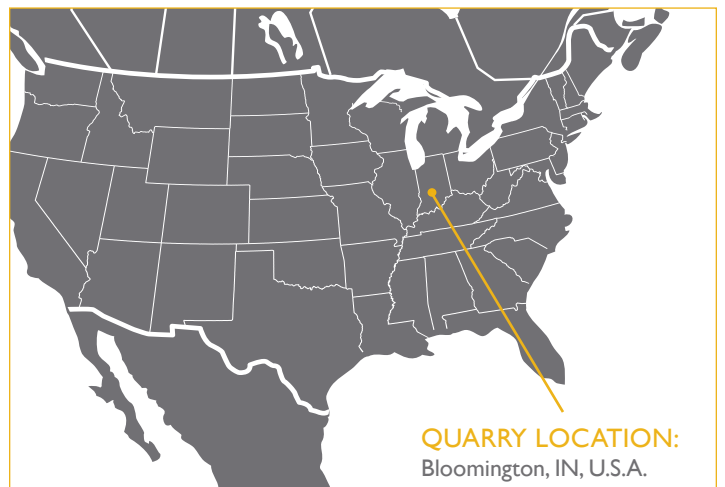

QUARRY LOCATION:
Bloomington, IN, U.S.A.

NATURALLY SUSTAINABLE™

Health Product Declaration® available **2020**
ANSI/NSC 373 Certified Quarry since **2018**



POLYCOR

QUARRY OWNERS | BLOCKS | SLABS | TILES | LANDSCAPING PRODUCTS | CURBS

polycor.com

Computer generated images and printed reproductions may not accurately match natural stone colors.

Front entry railing design reference

5.



[Visit site](#)

SIGNATURE
METALWORKS

6.



8" Aluminum Box Gutter

Home / 8" Box Gutter & Accessories / 8" Aluminum Box Gutter



\$6.50

Minimum order 20'. Our 8" x .040" Aluminum Box Gutter can be shipped in lengths of 6, 10, 15 and 19 feet. Gutter can also be shipped at 20 & 26 foot lengths, but is considered and rated as excessive length by freight companies. (6' maximum lengths shipped via UPS)

Available in low gloss white, almond, dark bronze, and royal brown (see Aluminum Color Chart below).

Price shown is **per foot**, please enter the **total number of feet needed** in the Quantity box. **IMPORTANT:** When you're checking out, you'll have the opportunity to specify the quantity of each length of gutter you need. You'll enter this info in the "Order Notes" box at checkout.

Gutter orders LONGER than 6' will be shipped via truck and subject to a MINIMUM shipping fee of \$150.00

One to five pieces of gutter can be sent UPS in 6' sections. UPS charges will run in the \$100 range. Please indicate in the "Order Notes" area at checkout whether you want a UPS or freight quote.

Each gutter and downspout order is unique at Classic Gutter Systems. Once you've placed your order on this website, you'll be contacted within 48 hours with a complete, detailed quote including packaging and shipping costs.

Color

Choose an option

- 1 +

Add to cart

Categories: 8" Box Gutter & Accessories, Bulky SKU: N/A

Tag: Gutter Systems



4" x .024 Aluminum Corrugated Round Downspout, Select Colors

Home / 4" Round Downspout / 4" x .024 Aluminum Corrugated Round Downspout, Select Colors

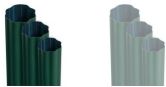
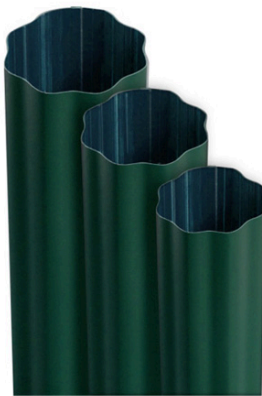

We recommend corrugated downspout for areas of the country that experience snow and ice. Corrugation allows for expansion in the event of ice build-up in the downspout, and also helps hide nicks and dents from daily exposure.

Note: Select Color corrugated aluminum downspout, shown here in Grecian Green, is priced the same per 10-foot length as our Standard Colors (see Aluminum Color Chart below).

Due to the machine setup required to produce Select Color Corrugated Downspout and Elbows, there is a \$100.00 up charge (one up charge per color, per order).

Downspout sections are available in 10' pre-cut lengths. Each box holds 60 ft. of 4" downspout. Don't forget to order additional downspout for elbow offsets and future repairs.

You will need to reduce the size of the opening on the elbows and downspout.

Downspout orders LONGER than 6' will be shipped via truck and subject to a MINIMUM shipping fee of \$150.00

One to three pieces of downspout can be sent UPS. The 10' downspout will be cut into 6' & 4' sections. UPS charges will run in the \$100 range. Please indicate in the "Order Notes" area at checkout whether you want a UPS or freight quote.

To order Corrugated Select Color Downspout, please call us at 269.665.2700.

Categories: 4" Round Downspout, Round Downspout SKU: DS4SC

Tag: Downspout Systems

Description Additional information

∨ STANDARD COLORS ∨

LOW GLOSS
& HIGH GLOSS
WHITE

DARK
BRONZE

ROYAL
BROWN

∨ SELECT COLORS ∨

ALMOND

BLACK

CLAY

COPPERTONE

GRECIAN
GREEN

LIGHT
BRONZE

MUSKET
BROWN

PEARL
GRAY

WICKER

Pella® Lifestyle Series

Clad/Wood



7.

#1 performing wood window and patio door for the combination of energy, sound and value.¹

Triple-pane casement



Dual-pane casement



- **Performance redefined**

You don't have to compromise on any aspect of performance. Available performance solutions offer an unbeatable combination of energy efficiency, sound control and value.¹

- **ENERGY STAR® certified²**

Pella products offer energy-efficient options that will meet or exceed ENERGY STAR guidelines in all 50 states. Pella Lifestyle Series products with triple-pane glass have been awarded ENERGY STAR Most Efficient Mark in 2023.

- **Enhanced sound control**

Our patented, triple-pane design with Advanced Low-E glass allows for mixed glass thickness for enhanced sound dampening resulting in an average 52% noise reduction versus single-pane windows.³

- **Popular features and options**

Low-maintenance aluminum-clad exteriors. Factory prefinish with a choice of several paints and stains, or choose primed or unfinished. Several grille types and patterns and high-transparency screens are also available.

- **Intentional design for improved durability**

Intentional jamb/sill design helps seal the end grain of the wood and elevates it off the rough opening, reducing the potential for moisture.

- **Durable 3-way corner joint**

Three-way corner joints are made up of mortise-and-tenon, metal fasteners and commercial adhesive for added strength and durability.

- **Low-maintenance exteriors**

Aluminum-clad exteriors with EnduraClad® finish resists fading and chalking. It is applied in an overlapping fashion for exceptional protection.

- **Exclusive wood protection**

Pella's exclusive EnduraGuard® wood protection is applied after the pieces have been cut and milled, but prior to final assembly. It provides advanced protection against the effects of moisture, decay, stains from mold and mildew — as well as termite damage.

- **Best limited lifetime warranty⁴**

Pella Lifestyle Series products are covered by the best limited lifetime warranty in the industry for wood windows and patio doors.⁴

- **Testing beyond requirements**

At Pella, our products are tested beyond requirements to help ensure they have long-lasting performance and reduce call-backs for you.

Available in these window and patio door styles:⁵



Special shape windows also available.

^{1,2,3,4,5} See back cover for disclosures.

EXTRUDED ALUMINUM-CLAD EXTERIORS

For exceptional durability, Pella Reserve products are available with extruded aluminum-clad exteriors. Choose from a wide variety of exterior colors or create a custom color to match your design. Low-maintenance EnduraClad exterior finish provides long-lasting beauty. EnduraClad Plus is also available.

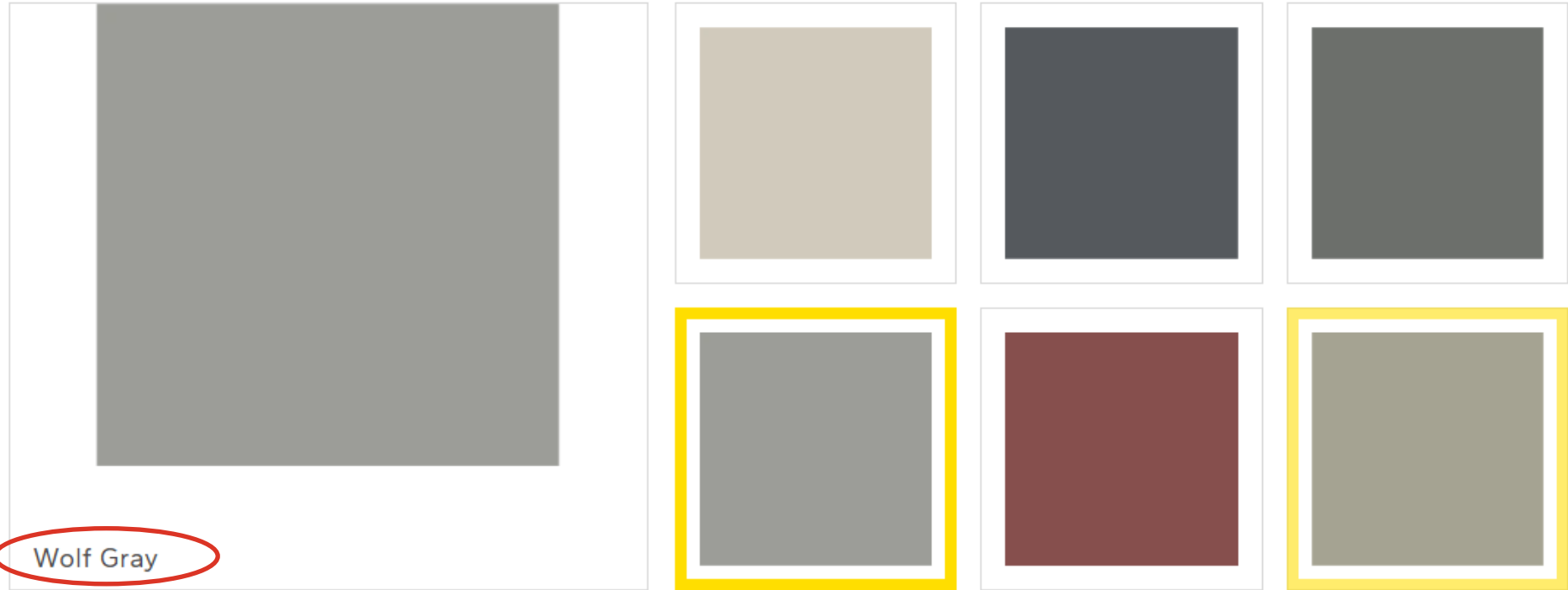

THERMA TRU[®] DOORS

Date

1/21/2025

Style Option = TS81RCL-FF

Steel Single

Impact Rating : None
Call Width : 3'0"
Call Height : 8'0"
Door Collection : Traditions Steel
Line : Pulse
Glass Shape : Pulse Linea
Style Shape : Pulse 8' Linea Offset Right
Glass Type : Clear Glass
Glass Design : Clear
Grille Pattern : None
Grille Style : None
Low-E? : No
Caming : None
Frame Profile : Flat Profile
Door Prefinish : Paint 1 Color
Door Paint Color : Granite
Jamb Prefinish : Paint 1 Color
Jamb Paint Color : Granite
Hardware : No Hardware
Would you like to include a storm door? : No

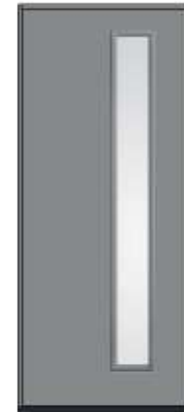



Home / Details

Insulated Steel Garage Doors

THERMACORE® COLLECTION - MODELS 5720, 5740 & 5760



[VIEW FULL GALLERY](#)

Thermacore® Collection insulated steel doors are the ideal choice for premium construction and maximum thermal efficiency. This series of doors feature construction of steel-polyurethane-steel as well as between-section seals with thermal breaks to reduce air infiltration. With several panel designs to choose from, these doors offer design flexibility, durability and thermal efficiency that will help keep your home comfortable in cold or hot climates.

Thermacore® Collection premium insulated garage doors deliver maximum thermal efficiency and design flexibility.

Learn more about our new Artisan Wood Grain™ finish options!

[DOORDREAMER™: VIEW THIS DOOR ON YOUR HOME](#)

[REQUEST A QUOTE](#)

[FIND A DISTRIBUTOR](#)

[Overview](#)

[Garage Door Designs](#)

[Colors](#)

[Windows & Hardware](#)

[Documents](#)

Construction

Product Specifications

5 Panel Options Available Standard, Flush, Long, Microgroove, Vertical Short and Vertical Long

Thermacore® Construction Provides a continuous layer of foamed-in-place, CFC-free polyurethane door insulation sandwiched between two layers of corrosion-resistant steel for maximum thermal efficiency

Polyurethane Garage Door Insulation Provides thermal efficiency
U-factor* of .20 (9.31 R-value**): Model 5720
U-factor* of .15 (12.76 R-value**): Model 5740
U-factor* of .10 (17.5 R-value**): Model 5760

Multiple Surface Options Embossed wood grain, microgroove wave pattern and smooth

Steel Backing For clean, finished interior appearance

Durable Finish Hot-dipped galvanized steel with two coats of baked-on polyester

Product Specifications

In-between Section Seals

Seals provide superior resistance to the elements

Bulb-type Bottom Weatherseal

Guards against wind and rain while providing a cushion when closing

Wind Load

Our WindStorm™ wind load rated system is available on selected products and meets all applicable building regulations for a variety of wind speeds, ensuring your door is built to withstand varying wind conditions, including hurricane-force winds, and meet or exceed the most stringent local building codes.

**U-factor values are independently tested and verified per ANSI/DASMA 105.*

***Overhead Door™ Brand uses a calculated door section R-value for our insulated doors.*



Overhead Door™ Brand participates in the DASMA Thermal Performance Verification Program. The program verifies the thermal performance of sectional doors. The lower the U-factor rating, the better the thermal performance.

 *Symbol indicates verified U-factor rating in accordance with the DASMA Thermal Performance Verification Program.*

Warranty

- 20-year limited warranty on Models 5720
- Limited lifetime warranty on door Models 5740 and Model 5760

Residential garage door and opener system limited warranty

- (when purchased together) - features 3 year on components (see warranty for details)

Thermacore® Collection premium insulated garage doors deliver maximum thermal efficiency and design flexibility.

Learn more about our new Artisan Wood Grain™ finish options!

[DOORDREAMER™: VIEW THIS DOOR ON YOUR HOME](#)

[REQUEST A QUOTE](#)

[FIND A DISTRIBUTOR](#)

[FIND A DISTRIBUTOR](#)



[Overview](#)

[Garage Door Designs](#)

[Colors](#)

[Windows & Hardware](#)

[Documents](#)

Color

Painted Finishes

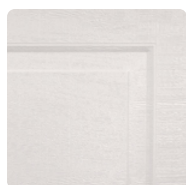

White



Almond



Desert Tan



Sandstone



Brown



Terra Bronze



Forest Green



Gray



Black



alumiLAST® Canopies/Sunshade Specifications

PRODUCT DESCRIPTION

An engineered aluminum canopy framing system designed for commercial and residential applications. The system is strong, lightweight, and maintenance free. The aluminum components have a durable powder coat finish, are saltwater resistant, and available in a wide choice of standard and custom colors. Endurable framing systems are fabricated to meet Uniform, BOCA, and National Building Code.

PART 1 GENERAL

1.1 WORK INCLUDED:

- A. Provide aluminum canopy framing system in prefabricated sections per approved engineering drawings.

1.2 REFERENCE STANDARDS:

- A. Uniform Building Code 1997
- B. BOCA National Building Code 1993
- C. IBC 2003, 2006, 2009 and 2015

1.3 SUBMITTALS:

- A. Provide shop drawings and product data.
- B. Within thirty calendar days after the contractor has received the owner's notice to proceed, submit shop drawings that indicate scope of project, component details, materials, finish, fasteners and anchorage methods, and the relationship to adjoining work
- C. Shop Drawings shall be signed and sealed by the professional engineer responsible for the design

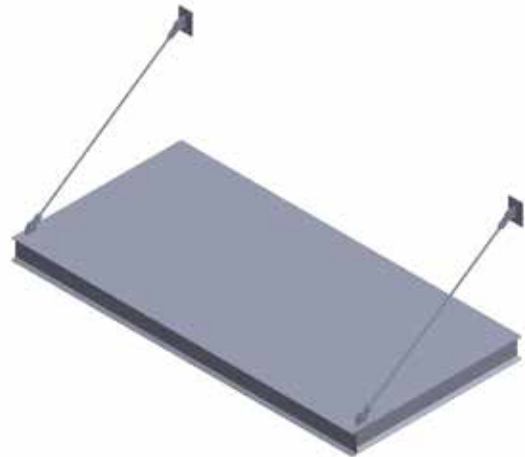

1.4 QUALITY ASSURANCE:

- A. Framing systems are based upon Endurable alumiLAST deck framing system as the standard of quality. No substitutions will be accepted.
- B. Design criteria: decking assemblies shall be designed to conform to all applicable building codes and loading requirements.

1.5 WARRANTY:

- A. 25 year warranty covering material and workmanship *(See manufacturer's warranty statement for specific details)*

1.6 DELIVERY, STORAGE, AND HANDLING:

- A. Deliver materials to the job site in good condition. Purchaser to store in clean, dry location, properly protected against damage to finished surfaces.
- B. Store away from uncured concrete, masonry, or stucco

Product Description

alumiLAST® Canopies/Sunshade Specifications



PART 2 PRODUCTS

2.1 MATERIALS:

- A. Extrusion Alloy: 6005A-T6, 6061-T6, or other 6000 series aluminum alloy.
- B. Screws, bolts, washers, hardware shall be stainless steel or other corrosion resistant material.

2.2 FINISHES:

- A. TGIC polyester powder coating, electro-statically applied to 2-3 mil thickness. Color to be selected by the architect/owner from manufacturer's standard or custom colors

2.3 FRAME COMPONENTS:

- A. Joists
 - 1. 1-1/2" x 3", 4", 5", 6 7/8" x 1/8" aluminum tube
- B. Perimeter Framing*
 - 1. 6" C-Channel or 1 1/2"x 6" or 2" x 8" x 1/8" aluminum tube
- C. Posts
 - 1. 3", 4", 6" x 1/8" square aluminum tube or snap fit aluminum columns.
- D. Plate
 - 1. 1/2" aluminum mounting plate
- E. Frame Enclosures
 - 1. .100 alum flat sheet – top & bottom (top welded on, bottom screwed on after installation)

* Subject to change based on span

2.4 FABRICATION:

- A. Fabricate canopy assembly to design dimensions, details, and specified requirements for structural performance. Fabricate members and fittings to provide flush, smooth, joints
- B. Owners representative/contractor to verify dimensions on site prior to fabrication

PART 3 EXECUTION

3.1 INSTALLATION:

- A. Install work in accordance with final shop drawings and manufacturer's instructions
- B. Erect work plumb, square and level, free from distortion or defects detrimental to appearance or performance
- C. Anchor posts to footings with approved corrosion resistant fasteners

3.2 CLEANING:

- A. Wash framing using clean water and soap, rinse with water
- B. Do not use acid solution, steel wool, or other harsh abrasive



Standard Balconies

We fabricate our standard alumiLAST® balconies using aluminum tube construction. We can combine these balconies with our aluminum decking or composite decking. These balconies feature welded aluminum railing supports with a variety of panels, and we deliver it to your site with the decking already installed and the railing and panels or pickets cut to fit and ready for easy installation.

These all-aluminum balconies usually attach to the building with lag bolts and threaded rods. However, alternative designs such as cantilevering, bolt-on or attaching with only knifeplates are possible. We match the attachment technique to meet your plan requirements.

Product Description

ENDURABLE
Building Products

alumiLAST® Decking General Information

PRODUCT DESCRIPTION

Endurable Building Products, the manufacturer of alumiLAST® deck and balcony frames, introduces alumiLAST® Decking, a line of powder coated aluminum decking. alumiLAST® decking features interlocking boards designed to be virtually watertight, and with the addition of a custom gasket, the boards can be completely watertight. Custom engineered starter strips and edge trim pieces are also available.

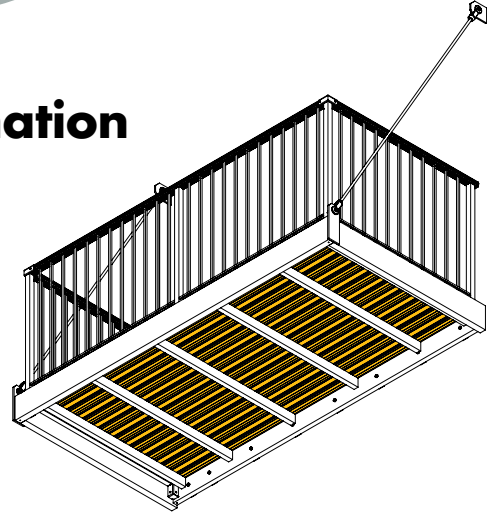

alumiLAST® DECKING FEATURES AND BENEFITS

Non-slip textured powder coat finish.

- Light weight. Boards weigh approximately 1 pound per foot.
- Low maintenance. Boards will not crack or split.
- Non-combustible. Aluminum will not burn.
- Five standard colors: Bronze, Black, Light Gray, Storm Gray & Wheat
(Custom colors also available).
- Limited Lifetime Warranty.
- 5 year powder coat finish warranty.

DECKING STANDARD COLORS

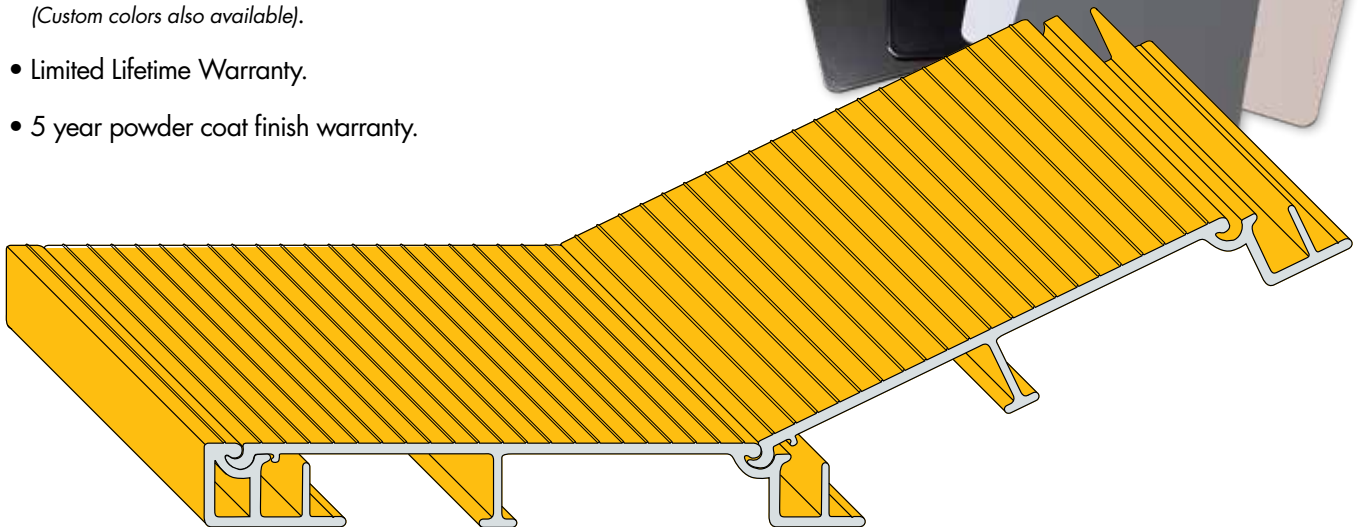

6500 Shingle Creek Parkway • Brooklyn Center, MN 55430

800.933.2060

www.endurable.com

Z-1080 LED

Wall Mounted Vertical Only • Wet Location Listed **LED**



Description:

Transform the mundane everyday with the sophisticated styling of this LED outdoor sconce. A smooth, elongated frame with a black finish dominates the design and exudes a modern attitude perfect for indoor or outdoor spaces. A beautiful, acrylic shade stretches into a rectangular form, held in place by simple metal bars at each end for a picture-perfect finish. Vertical mount only.

Specifications:

- White acrylic Diffuser
- A beautiful, acrylic shade stretches into a rectangular form, held in place by simple metal bars at each end for a picture-perfect finish.
- A smooth, elongated frame with a black finish dominates the design and exudes a modern attitude perfect for indoor or outdoor spaces.
- Transform the mundane everyday with the sophisticated styling of this LED outdoor sconce.
- Ideal for any foyer, bedroom, entryway, porch, or patio.
- Perfect for transitional, modern, or contemporary settings.
- Measures 5-inch width by 13-inch height.
- Uses one integrated LED (11w max).
- Compatible with many Triac/ELV dimmers (see dimming controls)
- Includes installation instructions and mounting hardware.
- Progress Lighting products are designed for exceptional quality, reliability, and functionality.
- Dimmable to 10% brightness (See Dimming Notes)
- Canopy covers a standard 4" recessed outlet box: 4.75 in W., 12.5 in ht., 1.875 in depth
- Mounting backplate for outlet box included
- 6 in of wire supplied
- Americans With Disabilities Act (ADA) compliant

Performance:

Number of Modules	1
Input Power	11 W
Input Voltage	120 V
Input Frequency	60 Hz
Lumens/LPW (Delivered)	415/37 (LM-79)
CCT	3000 K
CRI	90 CRI
Life (hours)	54000 (L70/TM-21)
EMI/RFI	FCC Title 47, Part 15, Class B
Warranty	5-year Limited Warranty
Labels	cCSAus Wet Location Listed
	ENERGY STAR® qualified
	Meets California Title 24 JA8-2016

P560210-031-30



A.

Dimensions:

Width: 5 in
Height: 13 in
Depth: 3 in
H/CTR: 6-1/2 in

White acrylic Diffuser
Width: 4-1/8 in
Height: 12-1/8 in

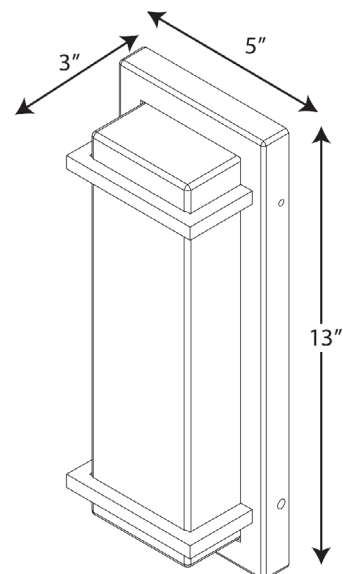

Dimming Notes:

P560210-031-30 is designed to be compatible with many Triac/ELV controls.

The following is a partial list of known compatible dimmer controls.

Dimming Controls:

Leviton IPI06-1LZ

Leviton 6674

Lutron NTEVL-300

Lutron DVELV-300P

Lutron AYCL-153P

Dimming capabilities will vary depending on the dimmer control, load, and circuit installation.

Always refer to dimmer manufacturer instructions or a controls specialist for specific requirements.

Dimmer control brand names where identified above are trade names or registered trademarks of each respective company.

P560210-031-30

Shipping to: **Ashburn, VA** ▼

B.

Maxim 13" Wide LED Outdoor Address Light

Model: 53610BZ | Item: bci3711150

from the [Address Collection](#)

★★★★★ (1)



\$60.00

Finish: Bronze - 1091 In Stock

Bronze



Free Shipping!

Leaves the Warehouse in 1 to 2 business days - [Shipping to 20147](#)

-

1

+

Add to Cart

Save to Project

 Compare[Return & Shipping Details](#)

Customers Also Viewed



Kichler 43800LED

\$88.95



Maxim 53651

\$78.00



Maxim 53650

\$74.00

Details



Make your home safer, more secure, and welcoming by providing your guests with an illuminated address light. Create an inviting entrance and make it easier for deliveries, our LED address light is available in your choice of Black, Bronze, or White with number tiles sold separately.

Features:

- For use with Maxim address numbers (not included)
- Durable aluminum construction
- ADA and Title 24 compliant
- Dark Sky approved
- cETLus rated for wet locations
- Covered under Maxim's 5 year manufacturer warranty

Dimensions:

- Height: 7"
- Width: 12-1/2"
- Extension: 2-1/4"
- Product Weight: 1.21 lbs
- Wire Length: 6"

Electrical Specifications:

- Wattage: 3W
- Lumens: 160
- Color Temperature: 3000K
- Color Rendering Index (CRI): 80
- Average Hours: 25000

Additional Maxim Links





- [View the Manufacturer Warranty](#)
- [Browse all Maxim Products](#)
- [Maxim Address Collection](#)

Manufacturer Resources



[Specification Sheet](#)

Dimensions and Measurements

Extension	 2.25 in.
Height	 7 in.
Nominal Height	 7 in.
Nominal Width	 13 in.
Product Weight	 1.21 lbs.
Width	 12.5 in.
Wire Length	 6 in.

Included Components

Bulb Included	 Yes
----------------------	---

shopbop



Pre-loved bags from top designers

Shop now

D.

Tools & Home Improvement > Lighting & Ceiling Fans > Outdoor Lighting > Porch & Patio Lights > Wall Lights



VIDEO



Roll over image to zoom in



wrasse Wall Washer Lights 36W Outdoor Sign Lighting Waterproof 5000K Plug in 38.9 Inches Outside Wall Wash Light bar for Commercial Advertising Boards Lighting

Brand: Wrasse
4.3 20 ratings |
[Search this page](#)

-10% \$96.29

List Price: ~~\$106.99~~

FREE Returns

Coupon: Apply 10% coupon

[Shop items >](#) | [Terms](#)

30-day refund/replacement |
Product support included

Color: 5000K

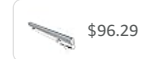

Brand wrasse
Color 5000K
Material Aluminum, Glass
Style Modern
Light fixture form Wall

About this item

- HIGH OUTPUT LIGHTING:**This 36W light bar operates at 5000K with a voltage range of AC86 to 265V, delivering an impressive 3600 lumens of brightness and offering extensive lighting coverage.
- MATERIAL&DURABILITY:** Crafted from high-quality aluminum housing and toughened glass, this outdoor wall washer light guarantees exceptional corrosion and oxidation resistance, ensuring long-term stability for outdoor wall washing. Its multi-slot design enhances heat dissipation efficiency.
- SAFE & WATERPROOF:**This outdoor sign lighting with a 10 x 60° wider angle and IP65 waterproof rating ensures durability in various weather conditions.
- COMMERCIALC &INDUSTRIAL:** this led linear light are perfect for commercial and

Add Prime to get **Fast, Free delivery**

\$96.29

FREE Returns

FREE delivery **Monday, January 27.** Order within 9 hrs 35 mins

Delivering to Ashburn 20149 - Update location

In Stock

Quantity: 1

Add to cart

Buy Now

Ships from Amazon
Sold by KHYZM
Returns 30-day refund/replacement
Support Product support included
[See more](#)

Add a Protection Plan:

- 3-Year Protection Plan for \$13.49
- 4-Year Protection Plan for \$17.99
- Asurion Complete Protect: One plan covers all eligible past and future purchases (Renews Monthly Until Cancelled) for \$16.99/month
- Add a gift receipt for easy returns

Add to List

Other sellers on Amazon

New & Used (2) from \$50.83 & FREE Shipping.

PREMIER STEEL 4-CAR CARPORT/GAZEBO

The ChikoUSA Premier Steel 4-Car Carport / Gazebo is the most cost effective solar canopy solution in the market today! This elegant structure is designed with a beam and column configuration resulting in superior strength. Ease and speed of install are two important design benefits. This structure can accommodate a variety of panel sizes and configurations. The steel coating of Zinc-Aluminum-Magnesium (Zn-Al-Mg) or ZAM provides the best In class protection while delivering superior corrosion resistance.

PRODUCT LINE

Item	Product Name
CK-QLCP-STEEL	Premier Steel 4-Car Carport/Gazebo

TECHNICAL DATA

Main Material	: S350 Steel Zinc Aluminum Magnesium (Zn-Al-Mg) Coated
Wind Velocity	: Up to 115MPH
Snow Load	: Up to 15 PSF
Tilt angle	: 5 Degrees
Module Orientation	: Landscape & Portrait
Foundation	: 3 Footer Options
Waterproof	: Optional
Module Type	: 60, 72 Cell & Large Format

ADVANTAGES

- Beautiful
- Easy installation
- Zinc Aluminum Magnesium (Zn-Al-Mg) Coated
- Anti-corrosion and anti-rust

FOOTER OPTIONS

Pier
Pad
Spread

WARRANTY



COMPONENT LIST

Material	QTY
Column	04
M-Rail	07
C-Channel	06
Column Base	04

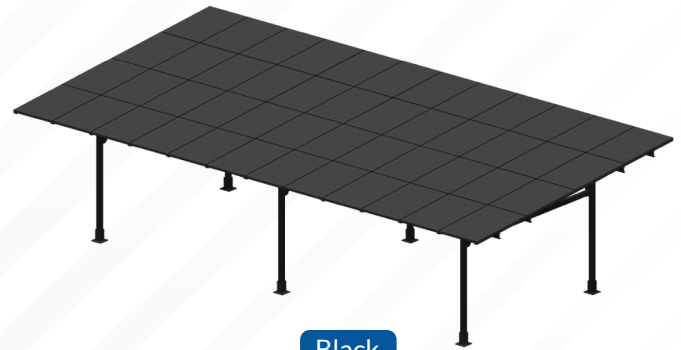

Black



Silver



Side Profile

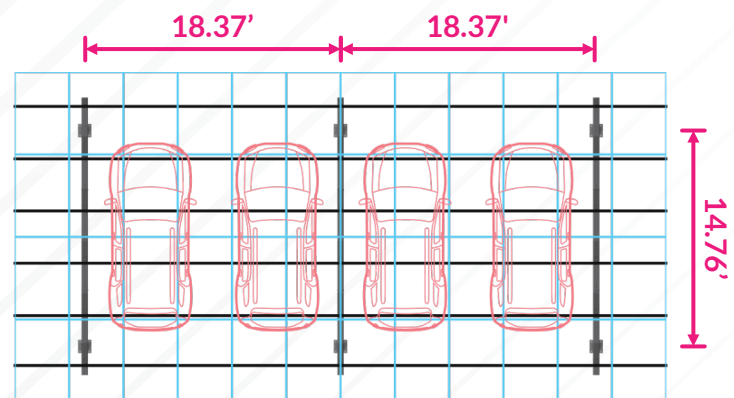

Overhead

