



HISTORIC DISTRICT COMMISSION APPLICATION FOR WORK APPROVAL

City of Detroit - Planning & Development Department
2 Woodward Avenue, Suite 808
Detroit, Michigan 48226

APPLICATION ID
HDC2024-00434

PROPERTY INFORMATION

ADDRESS(ES): 1624 EDISON ST
HISTORIC DISTRICT: Boston-Edison

SCOPE OF WORK: (Check ALL that apply)

- | | | | | | |
|--|---|--|--|---|--------------------------------|
| <input checked="" type="checkbox"/> Windows/ Doors | <input checked="" type="checkbox"/> Walls/ Siding | <input checked="" type="checkbox"/> Painting | <input type="checkbox"/> Roof/Gutters/ Chimney | <input type="checkbox"/> Porch/Deck/Balcony | <input type="checkbox"/> Other |
| <input type="checkbox"/> Demolition | <input type="checkbox"/> Signage | <input type="checkbox"/> New Building | <input type="checkbox"/> Addition | <input type="checkbox"/> Site Improvements (landscape, trees, fences, patios, etc.) | |

BRIEF PROJECT DESCRIPTION: FACADE REMODELING OF AN EXISTING HOUSE

APPLICANT IDENTIFICATION

TYPE OF APPLICANT: Architect/Engineer/Consultant			
NAME: Tarik Najib	COMPANY NAME: PROFESSIONAL CONSULTING COMPANY		
ADDRESS: 16970 WEST WARREN	CITY: DETROIT	STATE: MI	ZIP: 48228
PHONE: +1 (313) 583-0550	EMAIL: usapcc@gmail.com		

I AGREE TO AND AFFIRM THE FOLLOWING:

- I understand that the failure to upload all required documentation may result in extended review times for my project and/or a denied application.
- I understand that the review of this application by the Historic District Commission does not waive my responsibility to comply with any other applicable ordinances including obtaining appropriate permits (building, sign, etc.) or other department approvals prior to beginning the work.
- I hereby certify that the information on this application is true and correct. I certify that the proposed work is authorized by the owner of record and I have been authorized to make this application as the property owner(s) authorized agent.

DocuSigned by:
Tarik Najib
E6626E1986334B5...

08/20/2024

SIGNATURE

DATE





NOTE: Based on the scope of work, additional documentation may be required. See www.detroitmi.gov/hdc for scope-specific requirements.

PROJECT DETAILS – TELL US ABOUT YOUR PROJECT

Instructions: Add project details using the text box in each section. If your details exceed the space provided, attach the details via the attachment icon for that section.

ePLANS PERMIT NUMBER: <small>(only applicable if you've already applied for permits through ePLANS)</small>	BLD2024-01324
---	---------------

GENERAL

<p>1. DESCRIPTION OF EXISTING CONDITION <i>Please tell us about the current appearance and conditions of the areas you want to change. You may use a few sentences or attach a separate prepared document on the right. (For example, "existing roof on my garage is covered in gray asphalt shingles in poor condition.")</i></p> <p>- EXISTING GREY STONE OF THE HOUSE FACADE IS IN POOR CONDITION. - EXISTING WHITE VINYL SIDING OF THE HOUSE AND GARAGE FACAD IS IN POOR CONDITION. - EXISTING BROWN SHINGLES OF THE HOUSE AND GARAGE ROOFS ARE IN BAD CONDITION. - EXISTING EXTERIOR DOORS AND WINDOWS ARE IN BAD CONDITION.</p>	
<p>2. PHOTOGRAPHS <i>Help us understand your project. Please attach photographs of all areas where work is proposed.</i></p>	
<p>3. DESCRIPTION OF PROJECT <i>In this box, tell us about what you want to do at the areas described above in box #1. (For example, Install new asphalt shingle roofing at garage.)</i></p> <p>- PROPOSE E.I.F.S. ON THE HOUSE AND GARAGE EXTERIOR WALLS. - PROPOSE NEW HARDIE FIBER CEMENT BOARD SIDING ON THE HOUSE EXTERIOR WALLS. - PROPOSE NEW ASPHALT SHINGLE ROOFING AT THE GARAGE AND HOUSE. - INSTALL NEW DOORS. - INSTALL NEW WINDOWS.</p>	
<p>4. DETAILED SCOPE OF WORK <i>In this box, please describe all steps necessary to complete the work described in box #3. (For example, "remove existing shingles, replace wood deck as necessary, replace wood eaves, install roof vents, replace rotted fascia boards, paint, clean worksite.")</i></p> <p>- EXISTING STONE TO BE REPLACED WITH E.I.F.S. AT HOUSE. - EXISTING SIDING TO BE REPLACED WITH E.I.F.S. AT GARAGE . - EXISTING VINYL SIDING TO BE REPLACED WITH NEW HARD FIBER CEMENT BOARD SIDING AT THE HOUSE. - REMOVE EXISTING SHINGLES, REPLACE WOOD DECK AS NECESSARY, REPLACE WOOD EAVES REPLACE FASCIA BOARD AT THE GARAGE AND HOUSE. - EXISTING DOORS AND WINDOWS TO BE REPLACED WITH NEW ONES.</p>	
<p>5. BROCHURES/CUT SHEETS <i>Please provide information on the products or materials you are proposing to install. For example, a brochure on the brand and color of the shingles proposed.</i></p>	

ADDITIONAL DETAILS

6. WINDOWS/DOORS <i>Detailed photographs of window(s) and/or door(s) proposed for replacement showing the condition of the interior and exterior of the window(s) and/or door(s)</i>	



Foundation Building Materials
RETURN SERVICE REQUESTED

BRANCH 0028
35736 INDUSTRIAL RD
LIVONIA MI 48150
(248) 658-6206 PH
(248) 658-6210 FX

QUOTATION

QUOTATION #	CUSTOMER PO #	PAGE
8070594-00	franklin	1
QUOTE DATE	JOB # / NAME	
10/05/22		
PROMISED DATE	SHIP VIA	ORDER TAKEN BY
	ust Pick Up	Wiles, John
TERMS	ORDERED BY	SALES REP
NET 15 DAYS	franklin	28 House Acco



SHIP TO: CASH CUST-DET SPCL TERMS
35736 INDUSTRIAL RD
LIVONIA, MI 48150-1236
UNITED STATE

CUST #:
228

BILL TO: CASH COMMERCIAL 1 PRICING
FOUNDATION BUILDING MATERIALS
35766 INDUSTRIAL RD
LIVONIA, MI 48150-1236
nt

QUOTATION EXPIRES 30 DAYS FROM QUOTE DATE

Line No.	QTY Ord	Sell Unit	Product Code Product Description	Weight	UOM Qty	UOM	Price Unit (\$)	Sub Total (\$)
1	5	PK	EIFSFM1-18 EPS FOAM 1" X 24" X 48" (18/PK)		0.000	PK	43.00	215.00
2	32	PK	EIFSFM112-12 EPS FOAM 1.5" X 24" X 48 (12/PK)		0.000	PK	43.00	1376.00
3	3	CTN	EIFSWLMT3 WIND DEVIL 2 - W/ 2-1/2" 1000CT 2" FOAM WLMT-3		0.000	CTN	158.00	474.00
4	22	PL	STO80310-500 ESSENCE FINE SAND FINISH TSW 70LB 5GP		0.000	PL	68.00	1496.00
5	40	BAG	STO80101-050 STO PRIMER / ADHESIVE-B 50LB BAG (48 or 64/SKID)		0.000	BAG	39.00	1560.00
6	5	RL	STO81920-750 STO MESH 48" WIDE (4 ROLLS/BX) 150' RL		0.000	RL	151.00	755.00
7	10	RL	IPG-PE344855RS IPG 48MMx55M RED STUCCO TAPE UV30 PE34 RS 24/CS		0.000	RL	6.75	67.50
8	5	PL	STO81636-500 STOCOAT NEW GOLD COAT 55LB 5GAL PAIL		0.000	PL	157.00	785.00
9	4	RL	STO80208-750 STOGUARD FABRIC 4" WIDE (18 ROLL/BX) 1 RL		0.000	RL	38.00	152.00
10	2	EA	FLT400R EIFS PLASTIC FLOAT RED HANDLE W-F400R		0.000	EA	14.25	28.50
12	2	EA	KRA-PL551 KRAFT PL551 4 1/2 X11 SSSWEDISH TROWEL CB WOOD		0.000	EA	45.00	90.00

Qty Shipped Total:

130

Sub-Total	6,999.00
Delivery Chg	50.00
Taxes	422.94
Invoice Total	\$7,471.94

*1624 edison st
Det.*

Last Page

A signed purchase order is due within 30 days of the order date that appears on this quotation. Otherwise, we reserve the right to terminate this quotation and / or issue a replacement quote. A transportation surcharge will be applied for each delivered order. This quotation is conditioned upon buyer's acknowledgement and acceptance of FBM's Terms and conditions located at <https://www.fbmsales.com/salesterms>. Any new, additional or different terms are rejected.

Product Bulletin

Sto Primer/Adhesive-B

80101 Sto Primer/Adhesive-B

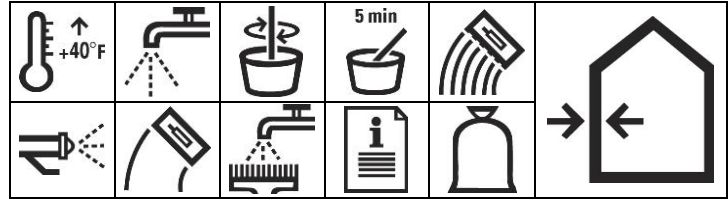

Technical Data

REPORT	TEST METHOD	TEST CRITERIA	TEST RESULTS
Surface Burning	ASTM E-84	< 25 Flame Spread < 450 Smoke Developed	0 5
Adhesion (psi)	ASTM C-297 Modified	28 days	> 20 Gypsum Sheathing* > 15 EPS Board* > 80 Concrete Block* > 35 Dens-Glass® Gold**
Impact Strength	EIMA 101.86	Standard Impact Classification	Pass

* Failure of substrate
 ** Dens-Glass Gold is a registered trademark of G-P Gypsum Corp.

Sto Primer/Adhesive-B is a one-component, polymer-modified, cement based, dry powder material used as an adhesive and base coat in the StoTherm® ci Systems.

Coverage
 "Through the wall": 55-70 ft² (5.1-6.5 m²) per bag (when used for both adhesive and base coat applications).

As an adhesive over sheathing and smooth masonry:
 90-125 ft² (8.4-11.6 m²) per bag, applied with a 1/2" x 1/2" (13 mm x 13 mm) U-notched trowel having 2" (51 mm) spread between notches.

As an adhesive over rough or uneven masonry:
 30-45 ft² (2.8-4.2 m²) per bag, applied with a 5/8" x 5/8" (16 mm x 16 mm) square-notched trowel, having 5/8" (16 mm) spread between notches.

As a base coat: 75-115 ft² (7-10.7 m²) per bag.

As a skim coat: 90-135 ft² (8.4-12.5 m²) per bag.

Coverages may vary depending on application technique and surface conditions.

Features Benefits

1 One-component	Ready to use; easily mixed with water on the job site
2 Polymer-modified	Excellent adhesion; increases durability and freeze/thaw resistance
3 Creamy smooth consistency	Trowels on easily; increases productivity
4 Vapor permeable	Allows substrate to breathe naturally; resists blisters caused by trapped vapor
5 Factory blended Portland cement	Assures performance mix ratio
6 Low cement ratio	Less alkalinity, less free lime, less efflorescence
7 Bagged powder product	Less solid waste than pails; freezing protection not required prior to mixing

Surface Preparation

As an adhesive
StoGuard® Air & Water-resistive Barrier (AWRB): ensure surface is clean, dry and free of surface contamination. Install StoTherm ci insulation board with adhesive to the AWRB within the allowable exposure period for the AWRB (see AWRB Product Bulletin).

Concrete or Masonry: surfaces must be clean, dry and free of frost, damage and all bond-inhibiting materials, including dirt, efflorescence, laitance, form oil and other foreign matter. Loose or damaged material must be removed by water blasting, sandblasting or mechanical wire brushing and repaired.

Avoid application over irregular surfaces. Resurface, patch or level surfaces to required tolerance and smoothness with appropriate Sto leveling materials. Refer to ASTM D-4258 and ASTM D-4261 for complete details on preparing cementitious substrates for coatings.

Glass Mat Gypsum Sheathing in Compliance with ASTM C 1177, Exterior or Exposure 1 Wood-based Sheathing: ensure surface is clean, dry and free of surface contamination. Sheathing must be installed and protected in accordance with manufacturer's and building code requirements. Remove and replace weather-damaged sheathing. Avoid application over irregular, out of plane surfaces. Install StoGuard AWRB within 30 days of installation of the sheathing (or as permitted by the sheathing manufacturer).

Packaging
 50 lb. bag (23 kg).

Shelf Life
 12 months, if properly stored and protected from moisture.

Storage
 Store off the ground in a dry area. Protect from extreme heat [90°F (32°C)], moisture and direct sunlight.



Product Bulletin

Sto Primer/Adhesive-B

Surface Preparation cont.

As a base coat

StoTherm ci Insulation Board: insulation must be rasped and free of all bond inhibiting materials.

Concrete or Masonry: surfaces must be clean, dry and free of frost, damage and all bond-inhibiting materials, including dirt, efflorescence, laitance, form oil and other foreign matter. Loose or damaged material must be removed by water blasting, sandblasting or mechanical wire brushing and repaired.

Mixing

Use 5-6.5 quarts (4.7-6.2 L) of water per 50 lb. bag (23 kg). Mix manually by adding one 50 lb. (23 kg) bag of Sto Primer/Adhesive-B to 5-6.5 quarts (4.7-6.2 L) of clean, potable water in a clean mixing pail. Mix with a clean, rust-free electric drill and paddle.

Allow to set approximately five minutes, adjust mix if necessary by adding up to 12 fl.oz. (0.35 L) of water per bag, and remix to a uniform consistency. Avoid re-tempering after mixing of product. Do not exceed maximum amount of water in mix ratio.

Application

Apply only to sound and clean, dry, properly prepared, frost-free surfaces.

As an adhesive: Apply to the back of the insulation board with the appropriate size notched trowel. Form uniform ribbons of adhesive parallel to the short dimension of the board so the ribbons are oriented vertically. Immediately install the board horizontally with staggered joints and apply firm uniform pressure over the entire board surface. Do not delay installation once adhesive is applied.

As a base coat: Apply with a stainless steel trowel to an approximate thickness of 1/8" (3 mm). Work horizontally or vertically in strips of 40" (1 m) and immediately embed Sto Mesh in the wet Sto Primer/Adhesive-B by troweling from the center to the edges of the mesh. Avoid wrinkles in the mesh and smooth the base coat to eliminate trowel marks.

Minimum recommended dry thickness of the reinforced base coat is 1/16" (1.6 mm) when dry. Reapply additional base coat if necessary to achieve minimum thickness as soon as the first application is dry.

As a skim coat: Apply in one application to a maximum thickness of 1/16" (1.6 mm) to the prepared surface and smooth the surface.

Curing/Drying

Dries within 24 hours under normal drying conditions [70°F (21°C), 50% RH]. Allow additional drying time during cold, humid, or wet weather until insulation board is fully adhered before rasping, and before application of primer or finish to hardened Sto Primer/Adhesive-B. Protect from rain, freezing and continuous high humidity until completely dry. Prevent rapid loss of moisture from exposure to direct sun, wind and high temperatures.

Clean Up

Clean tools and equipment with water immediately after use. Dried material can only be removed mechanically.

Limitations

- Use Sto Primer/Adhesive-B only when surface and ambient temperatures are above 40°F (4°C) during application and drying period.
- Sloped surfaces: Refer to Sto details.
- Sto Primer/Adhesive-B should not be used on weather-exposed horizontal or below grade surfaces or where immersion in water may occur.

- Sto Primer/Adhesive-B should not be used as a finish coating.
- Not for use over wood-based sheathing unless protected with appropriate StoGuard® AWRB.

Health And Safety

Health Precaution

Contains Portland cement and crystalline silica. Avoid breathing dust. As with any chemical construction product, exercise care when handling.

DANGER!

Causes serious eye damage and/or skin irritation. May cause an allergic skin reaction, respiratory irritation, drowsiness or dizziness.

Safety Precaution

Wash hands thoroughly after handling. Wear protective gloves/protective clothing/eye protection/face protection.

First Aid: EYE CONTACT:

Immediately flush eyes with plenty of water for at least 15 to 20 minutes. Ensure adequate flushing of the eyes by separating the eye lids with fingers. Get immediate medical attention.

SKIN CONTACT: Immediately wash skin with plenty of soap and water for at least 15 to 20 minutes, while removing contaminated clothing and shoes. Get medical attention if irritation develops or persists.

INHALATION: If inhaled, remove to fresh air. If not breathing give artificial respiration or give oxygen by trained personnel. Seek medical attention immediately. **INGESTION:** If swallowed, do NOT induce vomiting. Call a physician or a poison control center immediately. Never give anything by mouth to an unconscious person.

Spills

Collect in an appropriate container. Uncured material may be removed with water.

Disposal

Dispose of in accordance with local, state or federal regulations.

Warning

KEEP CONTAINER CLOSED WHEN NOT IN USE. KEEP OUT OF THE REACH OF CHILDREN. NOT FOR INTERNAL CONSUMPTION. FOR INDUSTRIAL USE ONLY. Consult the Safety Data Sheet (SDS) for further health and safety information.

LIMITED WARRANTY

This product is subject to a written limited warranty which can be obtained free of charge from Sto Corp. Refer to Sto Specifications for more complete information on proper use and handling of this product.

Sto Corp.
3800 Camp Creek Parkway
Building 1400, Suite 120
Atlanta, GA 30331

S155-80101
Revision: A3.2
Date: 05/2024

Tel: 404-346-3666
Toll Free: 1-800-221-2397
Fax: 404 346-3119

www.stocorp.com

Attention

This product is intended for use by qualified professional contractors, not consumers, as a component of a larger construction assembly as specified by a qualified design professional, general contractor or builder. It should be installed in accordance with those specifications and Sto's instructions. Sto Corp. disclaims all, and assumes no, liability for on-site inspections, for its products applied improperly, or by unqualified persons or entities, or as part of an improperly designed or constructed building, for the nonperformance of adjacent building components or assemblies, or for other construction activities beyond Sto's control. Improper use of this product or use as part of an improperly designed or constructed larger assembly or building may result in serious damage to this product, and to the structure of the building or its components. **STO CORP. DISCLAIMS ALL WARRANTIES EXPRESSED OR IMPLIED EXCEPT FOR EXPLICIT LIMITED WRITTEN WARRANTIES ISSUED TO AND ACCEPTED BY BUILDING OWNERS IN ACCORDANCE WITH STO'S WARRANTY PROGRAMS WHICH ARE SUBJECT TO CHANGE FROM TIME TO TIME.** For the fullest, most current information on proper application, clean-up, mixing and other specifications and warranties, cautions and disclaimers, please refer to the Sto Corp. website, www.stocorp.com.













Specs: Select Cedarmill® -

Width	12 in	5.25 in	5.25 in	5.25 in	5.25 in
Length	144 in	144 in	144 in	144 in	144 in
Thickness	0.312 in	0.312 in	0.312 in	0.312 in	0.312 in
ExposureWidth	10.75 in	4 in	4 in	4 in	4 in
Dream Collection®				•	
Primed for Paint	•				•
Statement Collection®		•			
Magnolia Home James Hardie Collection			•		

* Thickness 5/16 in and Length 12 ft planks for all

Specs: Smooth +

Specs: Beaded Select Cedarmill® +



Quick Start Installation Guide

Get an overview of the installation process for Hardie® Plank. In English and Spanish.

[Download PDF](#)



How to Install Hardie® Plank

From starter strips to correct gap length, it's important to know the basics for siding installation.

[Watch video](#)



Browse Tech Docs Library

Quickly browse and gather all the docs you need for a successful install project, from CAD files to install instructions to safety sheets.

[See docs for this product](#)



Select your color collection

Statement
Collection®

Magnolia Home | James
Hardie Collection

Primed for
Paint

🔍 Did not find the color you're looking for? [Click here.](#)

Select a color



Rich Espresso

Add sample to cart | Free 🛒

Visualize with Hover® →

Individual colors may vary depending on display settings. Samples only available in Select CedarMill® texture. Please check with your contractor or local dealer for availability in your area.



Hardie® Plank

Find your style

Your home is a blank canvas. Experiment with a variety of Hardie® Plank siding styles, textures, and stunning colors featuring our ColorPlus® Technology finishes to create your masterpiece.

Select your siding texture



Select Cedarmill®

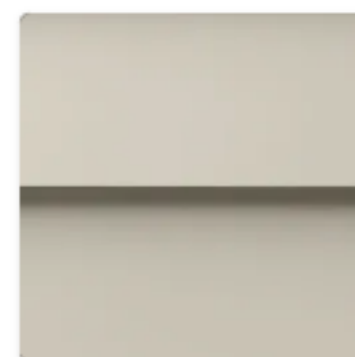

Smooth

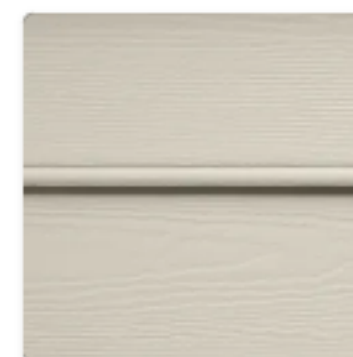

Beaded Select Cedarmill®

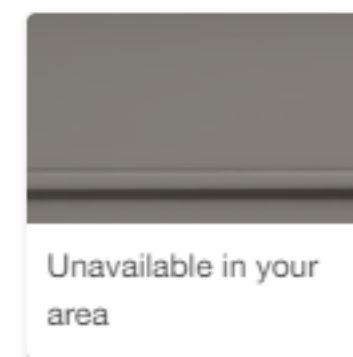

Unavailable in your area



Unavailable in your area

Custom Colonial Roughsawn



Unavailable in your area

Custom Colonial Smooth

Individual colors may vary depending on display settings. Samples only available in Select Cedarmill® texture. Please check with your contractor or local dealer for availability in your area.

Select your color collection



QUOTE BY: Brad Mintle

QUOTE #: JBFM02624

SOLD TO: The Home Depot #2703
 DARIN
 39825 Ford Road
 Canton, MI 48187

SHIP TO:

Phone: 734.844.7300

PROJECT NAME: CIAL REVISION

PO#: JBFM02550

REFERENCE: v3

Ship Via: Ground/Next Truck

U-Factor Weighted Average: 0.30

SHGC Weighted Average: 0.18

LINE NO.	LOCATION SIZE INFO	BOOK CODE DESCRIPTION	QTY
----------	-----------------------	--------------------------	-----

Line-1 ATTIC
 Rough Opening: 32 X 34 1/2

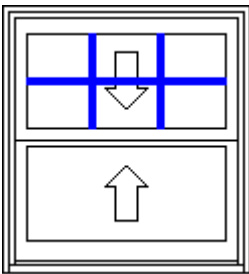

Viewed from Exterior. Scale: 1/2" = 1'

Frame Size : 31 1/4 X 33 3/4
 W-5500 Clad Double Hung, Auralast Pine,
 Luxury Bronze Exterior,
 Interior-Paint Perfect White/M64EXW31123,
 No Drip Cap/No Nail Fin,
 4 9/16 Jamb,
 Standard Double Hung, Window Opening Control Device (4" open)
 ASTM Compl White Jambliner, Concealed Jambliner
 Oil Rubbed Bronze Hardware,
 US National-WDMA/ASTM, PG 35,
 Insulated SunResist Annealed Glass, Protective Film, Black Spacer,
 Argon Filled, Traditional Glz Bd,
 Luxury Bronze SDL, 7/8" Putty SDL w/Perm Wood Putty Int BAR,
 Light Bronze Shadow Bar, Colonial Top Lite(s) Only 3 Wide 2 High
 Top,
 BetterVue Mesh Luxury Bronze Screen,
 Product Does Not Qualify for Accidental Glass Breakage Warranty
 Coverage, *Custom-Width*, *Custom-Height*, IGThick=0.698(3/32 /
 3/32),(To Calculate True Window or Patio Door Depth Add 1-1/4" To
 Specified Jamb Width).
 - WOCD must be disengaged to reach full clear opening
 U-Factor: 0.30, SHGC: 0.18, VLT: 0.42, Energy Rating: 12.00, CPD:
 JEL-N-880-03888-00001
 PEV 2023.4.0.4526/PDV 7.271 (12/01/23) CW

LINE NO.	LOCATION SIZE INFO	BOOK CODE DESCRIPTION	QTY
----------	-----------------------	--------------------------	-----

Line-2 ATTIC
Rough Opening: 31 1/2 X 43

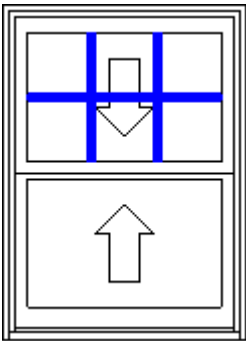

Viewed from Exterior. Scale: 1/2" = 1'

Frame Size : 30 3/4 X 42 1/4
W-5500 Clad Double Hung, Auralast Pine,
Luxury Bronze Exterior,
Interior-Paint Perfect White/M64EXW31123,
No Drip Cap/No Nail Fin,
4 9/16 Jamb,
Standard Double Hung, Window Opening Control Device (4" open)
ASTM Compl White Jambliner, Concealed Jambliner
Oil Rubbed Bronze Hardware,
US National-WDMA/ASTM, PG 35,
Insulated SunResist Annealed Glass, Protective Film, Black Spacer,
Argon Filled, Traditional Glz Bd,
Luxury Bronze SDL, 7/8" Putty SDL w/Perm Wood Putty Int BAR,
Light Bronze Shadow Bar, Colonial Top Lite(s) Only 3 Wide 2 High
Top,
BetterVue Mesh Luxury Bronze Screen,
Product Does Not Qualify for Accidental Glass Breakage Warranty
Coverage, *Custom-Width*, *Custom-Height*, IGThick=0.698(3/32 /
3/32),(To Calculate True Window or Patio Door Depth Add 1-1/4" To
Specified Jamb Width).
- WOCD must be disengaged to reach full clear opening
U-Factor: 0.30, SHGC: 0.18, VLT: 0.42, Energy Rating: 12.00, CPD:
JEL-N-880-03888-00001
PEV 2023.4.0.4526/PDV 7.271 (12/01/23) CW

1

Line-3 ATTIC STAIRS/ TEMP
Rough Opening: 31 1/2 X 49

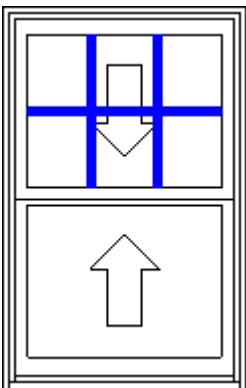

Viewed from Exterior. Scale: 1/2" = 1'

Frame Size : 30 3/4 X 48 1/4
W-5500 Clad Double Hung, Auralast Pine,
Luxury Bronze Exterior,
Interior-Paint Perfect White/M64EXW31123,
No Drip Cap/No Nail Fin,
4 9/16 Jamb,
Standard Double Hung, Window Opening Control Device (4" open)
ASTM Compl White Jambliner, Concealed Jambliner
Oil Rubbed Bronze Hardware,
US National-WDMA/ASTM, PG 35,
Insulated SunResist Tempered Glass, Protective Film, Black Spacer,
Argon Filled, Traditional Glz Bd,
Luxury Bronze SDL, 7/8" Putty SDL w/Perm Wood Putty Int BAR,
Light Bronze Shadow Bar, Colonial Top Lite(s) Only 3 Wide 2 High
Top,
BetterVue Mesh Luxury Bronze Screen,
Product Warranty Covers Accidental* Glass Breakage *Refer to the
JELD-WEN warranty for additional information, *Custom-Width*,
Custom-Height, IGThick=0.726(1/8 / 1/8),(To Calculate True
Window or Patio Door Depth Add 1-1/4" To Specified Jamb Width).
- WOCD must be disengaged to reach full clear opening
U-Factor: 0.30, SHGC: 0.18, VLT: 0.41, Energy Rating: 12.00, CPD:
JEL-N-880-04003-00001
PEV 2023.4.0.4526/PDV 7.271 (12/01/23) CW

2

LINE NO.	LOCATION SIZE INFO	BOOK CODE DESCRIPTION	QTY
----------	-----------------------	--------------------------	-----

Line-4 2ND FL BATH
 TEMP/OBS/GRIDS

Rough Opening: 31 1/2 X 44 1/4

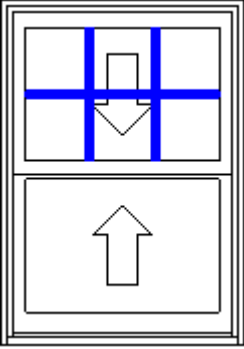

Viewed from Exterior. Scale: 1/2" = 1'

Frame Size : 30 3/4 X 43 1/2
W-5500 Clad Double Hung, Auralast Pine,
Luxury Bronze Exterior,
Interior-Paint Perfect White/M64EXW31123,
No Drip Cap/No Nail Fin,
4 9/16 Jamb,
Standard Double Hung, Window Opening Control Device (4" open)
ASTM Compl White Jambliner, Concealed Jambliner
Oil Rubbed Bronze Hardware,
US National-WDMA/ASTM, PG 35,
Insulated SunResist Tempered Glass, Protective Film, Black Spacer,
Argon Filled, Traditional Glz Bd,
Luxury Bronze SDL, 7/8" Putty SDL w/Perm Wood Putty Int BAR,
Light Bronze Shadow Bar, Colonial Top Lite(s) Only 3 Wide 2 High
Top,
BetterVue Mesh Luxury Bronze Screen,
Product Warranty Covers Accidental* Glass Breakage *Refer to the
JELD-WEN warranty for additional information, *Custom-Width*,
Custom-Height, IGThick=0.726(1/8 / 1/8),(To Calculate True
Window or Patio Door Depth Add 1-1/4" To Specified Jamb Width).
- WOCD must be disengaged to reach full clear opening
U-Factor: 0.30, SHGC: 0.18, VLT: 0.41, Energy Rating: 12.00, CPD:
JEL-N-880-04003-00001
PEV 2023.3.0.4442/PDV 7.191 (09/06/23) CW

1

Line-5 2ND FL
Rough Opening: 31 1/2 X 54

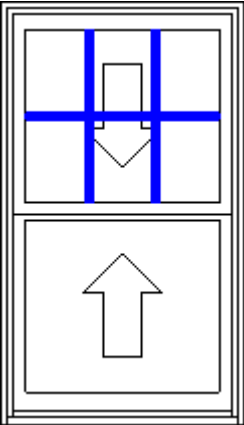

Viewed from Exterior. Scale: 1/2" = 1'

Frame Size : 30 3/4 X 53 1/4
W-5500 Clad Double Hung, Auralast Pine,
Luxury Bronze Exterior,
Interior-Paint Perfect White/M64EXW31123,
No Drip Cap/No Nail Fin,
4 9/16 Jamb,
Standard Double Hung, Window Opening Control Device (4" open)
ASTM Compl White Jambliner, Concealed Jambliner
Oil Rubbed Bronze Hardware,
US National-WDMA/ASTM, PG 35,
Insulated SunResist Annealed Glass, Protective Film, Black Spacer,
Argon Filled, Traditional Glz Bd,
Luxury Bronze SDL, 7/8" Putty SDL w/Perm Wood Putty Int BAR,
Light Bronze Shadow Bar, Colonial Top Lite(s) Only 3 Wide 2 High
Top,
BetterVue Mesh Luxury Bronze Screen,
Product Does Not Qualify for Accidental Glass Breakage Warranty
Coverage, *Custom-Width*, *Custom-Height*, IGThick=0.698(3/32 /
3/32),(To Calculate True Window or Patio Door Depth Add 1-1/4" To
Specified Jamb Width).
- WOCD must be disengaged to reach full clear opening
U-Factor: 0.30, SHGC: 0.18, VLT: 0.42, Energy Rating: 12.00, CPD:
JEL-N-880-03888-00001
PEV 2023.4.0.4526/PDV 7.271 (12/01/23) CW

1

LINE NO.	LOCATION SIZE INFO	BOOK CODE DESCRIPTION	QTY
----------	-----------------------	--------------------------	-----

Line-6 2ND FL
Rough Opening: 34 1/2 X 56

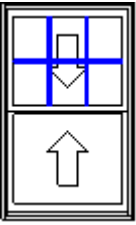

Viewed from Exterior. Scale: 1/4" = 1'

Frame Size : 33 3/4 X 55 1/4
W-5500 Clad Double Hung, Auralast Pine,
Luxury Bronze Exterior,
Interior-Paint Perfect White/M64EXW31123,
No Drip Cap/No Nail Fin,
4 9/16 Jamb,
Standard Double Hung, Window Opening Control Device (4" open)
ASTM Compl White Jambliner, Concealed Jambliner
Oil Rubbed Bronze Hardware,
US National-WDMA/ASTM, PG 35,
Insulated SunResist Annealed Glass, Protective Film, Black Spacer,
Argon Filled, Traditional Glz Bd,
Luxury Bronze SDL, 7/8" Putty SDL w/Perm Wood Putty Int BAR,
Light Bronze Shadow Bar, Colonial Top Lite(s) Only 3 Wide 2 High
Top,
BetterVue Mesh Luxury Bronze Screen,
Product Does Not Qualify for Accidental Glass Breakage Warranty
Coverage, *Custom-Width*, *Custom-Height*, IGThick=0.698(3/32 /
3/32),(To Calculate True Window or Patio Door Depth Add 1-1/4" To
Specified Jamb Width).
- WOCD must be disengaged to reach full clear opening
U-Factor: 0.30, SHGC: 0.18, VLT: 0.42, Energy Rating: 12.00, CPD:
JEL-N-880-03888-00001
PEV 2023.4.0.4526/PDV 7.271 (12/01/23) CW

1

Line-7 2ND FL
Rough Opening: 34 1/2 X 56

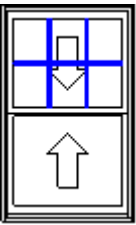

Viewed from Exterior. Scale: 1/4" = 1'

Frame Size : 33 3/4 X 55 1/4
W-5500 Clad Double Hung, Auralast Pine,
Luxury Bronze Exterior,
Interior-Paint Perfect White/M64EXW31123,
No Drip Cap/No Nail Fin,
4 9/16 Jamb,
Standard Double Hung, Window Opening Control Device (4" open)
ASTM Compl White Jambliner, Concealed Jambliner
Oil Rubbed Bronze Hardware,
US National-WDMA/ASTM, PG 35,
Insulated SunResist Annealed Glass, Protective Film, Black Spacer,
Argon Filled, Traditional Glz Bd,
Luxury Bronze SDL, 7/8" Putty SDL w/Perm Wood Putty Int BAR,
Light Bronze Shadow Bar, Colonial Top Lite(s) Only 3 Wide 2 High
Top,
BetterVue Mesh Luxury Bronze Screen,
Product Does Not Qualify for Accidental Glass Breakage Warranty
Coverage, *Custom-Width*, *Custom-Height*, IGThick=0.698(3/32 /
3/32),(To Calculate True Window or Patio Door Depth Add 1-1/4" To
Specified Jamb Width).
- WOCD must be disengaged to reach full clear opening
U-Factor: 0.30, SHGC: 0.18, VLT: 0.42, Energy Rating: 12.00, CPD:
JEL-N-880-03888-00001
PEV 2023.4.0.4526/PDV 7.271 (12/01/23) CW

1

LINE NO.	LOCATION SIZE INFO	BOOK CODE DESCRIPTION	QTY
----------	-----------------------	--------------------------	-----

Line-8 2ND FL

Rough Opening: 24 X 55

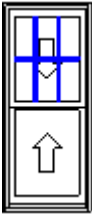

Viewed from Exterior. Scale: 1/4" = 1'

Frame Size : 23 1/4 X 54 1/4
 W-5500 Clad Double Hung, Auralast Pine,
 Luxury Bronze Exterior,
 Interior-Paint Perfect White/M64EXW31123,
 No Drip Cap/No Nail Fin,
 4 9/16 Jamb,
 Standard Double Hung, Window Opening Control Device (4" open)
 ASTM Compl White Jambliner, Concealed Jambliner
 Oil Rubbed Bronze Hardware,
 US National-WDMA/ASTM, PG 35,
 Insulated SunResist Annealed Glass, Protective Film, Black Spacer,
 Argon Filled, Traditional Glz Bd,
 Luxury Bronze SDL, 7/8" Putty SDL w/Perm Wood Putty Int BAR,
 Light Bronze Shadow Bar, Colonial Top Lite(s) Only 3 Wide 2 High
 Top,
 BetterVue Mesh Luxury Bronze Screen,
 Product Does Not Qualify for Accidental Glass Breakage Warranty
 Coverage, *Custom-Width*, *Custom-Height*, IGTThick=0.698(3/32 /
 3/32),(To Calculate True Window or Patio Door Depth Add 1-1/4" To
 Specified Jamb Width).
 - WOCD must be disengaged to reach full clear opening
 U-Factor: 0.30, SHGC: 0.18, VLT: 0.42, Energy Rating: 12.00, CPD:
 JEL-N-880-03888-00001
 PEV 2023.4.0.4526/PDV 7.271 (12/01/23) CW

2

Line-9 2ND FL

Rough Opening: 34 1/2 X 56

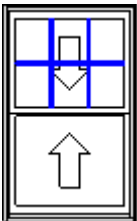

Viewed from Exterior. Scale: 1/4" = 1'

Frame Size : 33 3/4 X 55 1/4
 W-5500 Clad Double Hung, Auralast Pine,
 Luxury Bronze Exterior,
 Interior-Paint Perfect White/M64EXW31123,
 No Drip Cap/No Nail Fin,
 4 9/16 Jamb,
 Standard Double Hung, Window Opening Control Device (4" open)
 ASTM Compl White Jambliner, Concealed Jambliner
 Oil Rubbed Bronze Hardware,
 US National-WDMA/ASTM, PG 35,
 Insulated SunResist Annealed Glass, Protective Film, Black Spacer,
 Argon Filled, Traditional Glz Bd,
 Luxury Bronze SDL, 7/8" Putty SDL w/Perm Wood Putty Int BAR,
 Light Bronze Shadow Bar, Colonial Top Lite(s) Only 3 Wide 2 High
 Top,
 BetterVue Mesh Luxury Bronze Screen,
 Product Does Not Qualify for Accidental Glass Breakage Warranty
 Coverage, *Custom-Width*, *Custom-Height*, IGTThick=0.698(3/32 /
 3/32),(To Calculate True Window or Patio Door Depth Add 1-1/4" To
 Specified Jamb Width).
 - WOCD must be disengaged to reach full clear opening
 U-Factor: 0.30, SHGC: 0.18, VLT: 0.42, Energy Rating: 12.00, CPD:
 JEL-N-880-03888-00001
 PEV 2023.4.0.4526/PDV 7.271 (12/01/23) CW

2

LINE NO.	LOCATION SIZE INFO	BOOK CODE DESCRIPTION	QTY
----------	-----------------------	--------------------------	-----

Line-10 2ND FL
 Rough Opening: 31 1/2 X 54

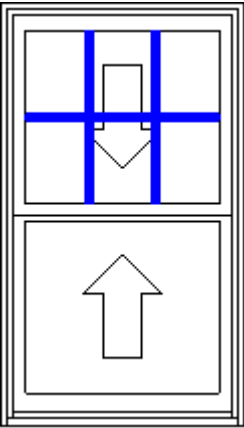

Viewed from Exterior. Scale: 1/2" = 1'

Frame Size : 30 3/4 X 53 1/4
 W-5500 Clad Double Hung, Auralast Pine,
 Luxury Bronze Exterior,
 Interior-Paint Perfect White/M64EXW31123,
 No Drip Cap/No Nail Fin,
 4 9/16 Jamb,
 Standard Double Hung, Window Opening Control Device (4" open)
 ASTM Compl White Jambliner, Concealed Jambliner
 Oil Rubbed Bronze Hardware,
 US National-WDMA/ASTM, PG 35,
 Insulated SunResist Annealed Glass, Protective Film, Black Spacer,
 Argon Filled, Traditional Glz Bd,
 Luxury Bronze SDL, 7/8" Putty SDL w/Perm Wood Putty Int BAR,
 Light Bronze Shadow Bar, Colonial Top Lite(s) Only 3 Wide 2 High
 Top,
 BetterVue Mesh Luxury Bronze Screen,
 Product Does Not Qualify for Accidental Glass Breakage Warranty
 Coverage, *Custom-Width*, *Custom-Height*, IGThick=0.698(3/32 /
 3/32),(To Calculate True Window or Patio Door Depth Add 1-1/4" To
 Specified Jamb Width).
 - WOCD must be disengaged to reach full clear opening
 U-Factor: 0.30, SHGC: 0.18, VLT: 0.42, Energy Rating: 12.00, CPD:
 JEL-N-880-03888-00001
 PEV 2023.4.0.4526/PDV 7.271 (12/01/23) CW

1

Line-11 2ND FL
 Rough Opening: 31 1/4 X 54

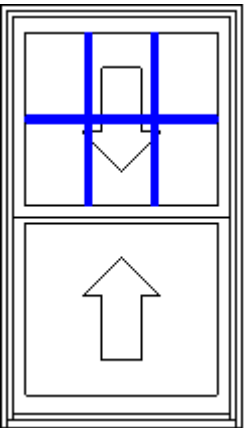

Viewed from Exterior. Scale: 1/2" = 1'

Frame Size : 30 1/2 X 53 1/4
 W-5500 Clad Double Hung, Auralast Pine,
 Luxury Bronze Exterior,
 Interior-Paint Perfect White/M64EXW31123,
 No Drip Cap/No Nail Fin,
 4 9/16 Jamb,
 Standard Double Hung, Window Opening Control Device (4" open)
 ASTM Compl White Jambliner, Concealed Jambliner
 Oil Rubbed Bronze Hardware,
 US National-WDMA/ASTM, PG 35,
 Insulated SunResist Annealed Glass, Protective Film, Black Spacer,
 Argon Filled, Traditional Glz Bd,
 Luxury Bronze SDL, 7/8" Putty SDL w/Perm Wood Putty Int BAR,
 Light Bronze Shadow Bar, Colonial Top Lite(s) Only 3 Wide 2 High
 Top,
 BetterVue Mesh Luxury Bronze Screen,
 Product Does Not Qualify for Accidental Glass Breakage Warranty
 Coverage, *Custom-Width*, *Custom-Height*, IGThick=0.698(3/32 /
 3/32),(To Calculate True Window or Patio Door Depth Add 1-1/4" To
 Specified Jamb Width).
 - WOCD must be disengaged to reach full clear opening
 U-Factor: 0.30, SHGC: 0.18, VLT: 0.42, Energy Rating: 12.00, CPD:
 JEL-N-880-03888-00001
 PEV 2023.4.0.4526/PDV 7.271 (12/01/23) CW

1

LINE NO.	LOCATION SIZE INFO	BOOK CODE DESCRIPTION	QTY
----------	-----------------------	--------------------------	-----

Line-12 2ND FL
 Rough Opening: 31 1/4 X 54 1/2

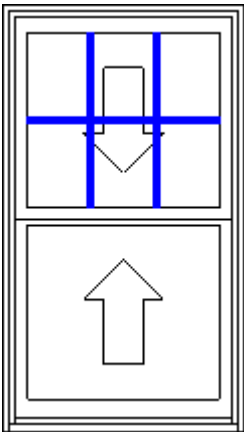

Viewed from Exterior. Scale: 1/2" = 1'

Frame Size : 30 1/2 X 53 3/4
 W-5500 Clad Double Hung, Auralast Pine,
 Luxury Bronze Exterior,
 Interior-Paint Perfect White/M64EXW31123,
 No Drip Cap/No Nail Fin,
 4 9/16 Jamb,
 Standard Double Hung, Window Opening Control Device (4" open)
 ASTM Compl White Jambliner, Concealed Jambliner
 Oil Rubbed Bronze Hardware,
 US National-WDMA/ASTM, PG 35,
 Insulated SunResist Annealed Glass, Protective Film, Black Spacer,
 Argon Filled, Traditional Glz Bd,
 Luxury Bronze SDL, 7/8" Putty SDL w/Perm Wood Putty Int BAR,
 Light Bronze Shadow Bar, Colonial Top Lite(s) Only 3 Wide 2 High
 Top,
 BetterVue Mesh Luxury Bronze Screen,
 Product Does Not Qualify for Accidental Glass Breakage Warranty
 Coverage, *Custom-Width*, *Custom-Height*, IGThick=0.698(3/32 /
 3/32),(To Calculate True Window or Patio Door Depth Add 1-1/4" To
 Specified Jamb Width).
 - WOCD must be disengaged to reach full clear opening
 U-Factor: 0.30, SHGC: 0.18, VLT: 0.42, Energy Rating: 12.00, CPD:
 JEL-N-880-03888-00001
 PEV 2023.4.0.4526/PDV 7.271 (12/01/23) CW

1

Line-13 2ND FL
 Rough Opening: 33 1/2 X 54 1/4

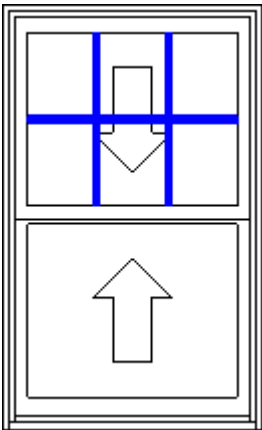

Viewed from Exterior. Scale: 1/2" = 1'

Frame Size : 32 3/4 X 53 1/2
 W-5500 Clad Double Hung, Auralast Pine,
 Luxury Bronze Exterior,
 Interior-Paint Perfect White/M64EXW31123,
 No Drip Cap/No Nail Fin,
 4 9/16 Jamb,
 Standard Double Hung, Window Opening Control Device (4" open)
 ASTM Compl White Jambliner, Concealed Jambliner
 Oil Rubbed Bronze Hardware,
 US National-WDMA/ASTM, PG 35,
 Insulated SunResist Annealed Glass, Protective Film, Black Spacer,
 Argon Filled, Traditional Glz Bd,
 Luxury Bronze SDL, 7/8" Putty SDL w/Perm Wood Putty Int BAR,
 Light Bronze Shadow Bar, Colonial Top Lite(s) Only 3 Wide 2 High
 Top,
 BetterVue Mesh Luxury Bronze Screen,
 Product Does Not Qualify for Accidental Glass Breakage Warranty
 Coverage, *Custom-Width*, *Custom-Height*, IGThick=0.698(3/32 /
 3/32),(To Calculate True Window or Patio Door Depth Add 1-1/4" To
 Specified Jamb Width).
 - WOCD must be disengaged to reach full clear opening
 U-Factor: 0.30, SHGC: 0.18, VLT: 0.42, Energy Rating: 12.00, CPD:
 JEL-N-880-03888-00001
 PEV 2023.4.0.4526/PDV 7.271 (12/01/23) CW

2

LINE NO.	LOCATION SIZE INFO	BOOK CODE DESCRIPTION	QTY
----------	-----------------------	--------------------------	-----

Line-14 2ND FL
 Rough Opening: 34 1/2 X 55 1/2

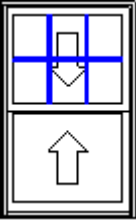

Viewed from Exterior. Scale: 1/4" = 1'

Frame Size : 33 3/4 X 54 3/4
 W-5500 Clad Double Hung, Auralast Pine,
 Luxury Bronze Exterior,
 Interior-Paint Perfect White/M64EXW31123,
 No Drip Cap/No Nail Fin,
 4 9/16 Jamb,
 Standard Double Hung, Window Opening Control Device (4" open)
 ASTM Compl White Jambliner, Concealed Jambliner
 Oil Rubbed Bronze Hardware,
 US National-WDMA/ASTM, PG 35,
 Insulated SunResist Annealed Glass, Protective Film, Black Spacer,
 Argon Filled, Traditional Glz Bd,
 Luxury Bronze SDL, 7/8" Putty SDL w/Perm Wood Putty Int BAR,
 Light Bronze Shadow Bar, Colonial Top Lite(s) Only 3 Wide 2 High
 Top,
 BetterVue Mesh Luxury Bronze Screen,
 Product Does Not Qualify for Accidental Glass Breakage Warranty
 Coverage, *Custom-Width*, *Custom-Height*, IGThick=0.698(3/32 /
 3/32),(To Calculate True Window or Patio Door Depth Add 1-1/4" To
 Specified Jamb Width).
 - WOCD must be disengaged to reach full clear opening
 U-Factor: 0.30, SHGC: 0.18, VLT: 0.42, Energy Rating: 12.00, CPD:
 JEL-N-880-03888-00001
 PEV 2023.4.0.4526/PDV 7.271 (12/01/23) CW

1

Line-15 1ST FL
 Rough Opening: 34 X 55 3/4

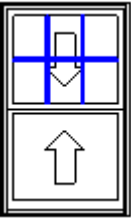

Viewed from Exterior. Scale: 1/4" = 1'

Frame Size : 33 1/4 X 55
 W-5500 Clad Double Hung, Auralast Pine,
 Luxury Bronze Exterior,
 Interior-Paint Perfect White/M64EXW31123,
 No Drip Cap/No Nail Fin,
 4 9/16 Jamb,
 Standard Double Hung, White Jambliner, Concealed Jambliner
 Oil Rubbed Bronze Hardware,
 US National-WDMA/ASTM, PG 35,
 Insulated SunResist Annealed Glass, Protective Film, Black Spacer,
 Argon Filled, Traditional Glz Bd,
 Luxury Bronze SDL, 7/8" Putty SDL w/Perm Wood Putty Int BAR,
 Light Bronze Shadow Bar, Colonial Top Lite(s) Only 3 Wide 2 High
 Top,
 BetterVue Mesh Luxury Bronze Screen,
 Product Does Not Qualify for Accidental Glass Breakage Warranty
 Coverage, *Custom-Width*, *Custom-Height*, IGThick=0.698(3/32 /
 3/32),(To Calculate True Window or Patio Door Depth Add 1-1/4" To
 Specified Jamb Width).
 Clear Opening:29.5w, 23.9h, 4.9 sf

 U-Factor: 0.30, SHGC: 0.18, VLT: 0.42, Energy Rating: 12.00, CPD:
 JEL-N-880-03888-00001
 PEV 2023.4.0.4526/PDV 7.271 (12/01/23) CW

1

LINE NO.	LOCATION SIZE INFO	BOOK CODE DESCRIPTION	QTY
----------	-----------------------	--------------------------	-----

Line-16 2ND FL

Rough Opening: 24 X 56

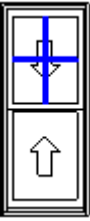

Viewed from Exterior. Scale: 1/4" = 1'

Frame Size : 23 1/4 X 55 1/4
 W-5500 Clad Double Hung, Auralast Pine,
 Luxury Bronze Exterior,
 Interior-Paint Perfect White/M64EXW31123,
 No Drip Cap/No Nail Fin,
 4 9/16 Jamb,
 Standard Double Hung, Window Opening Control Device (4" open)
 ASTM Compl White Jambliner, Concealed Jambliner
 Oil Rubbed Bronze Hardware,
 US National-WDMA/ASTM, PG 35,
 Insulated SunResist Annealed Glass, Protective Film, Black Spacer,
 Argon Filled, Traditional Glz Bd,
 Luxury Bronze SDL, 7/8" Putty SDL w/Perm Wood Putty Int BAR,
 Light Bronze Shadow Bar, Colonial Top Lite(s) Only 2 Wide 2 High
 Top,
 BetterVue Mesh Luxury Bronze Screen,
 Product Does Not Qualify for Accidental Glass Breakage Warranty
 Coverage, *Custom-Width*, *Custom-Height*, IGTick=0.698(3/32 /
 3/32),(To Calculate True Window or Patio Door Depth Add 1-1/4" To
 Specified Jamb Width).
 - WOCD must be disengaged to reach full clear opening
 U-Factor: 0.30, SHGC: 0.18, VLT: 0.42, Energy Rating: 12.00, CPD:
 JEL-N-880-03888-00001
 PEV 2023.4.0.4526/PDV 7.271 (12/01/23) CW

2

Line-17 2ND FL

Rough Opening: 34 X 56

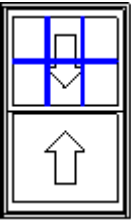

Viewed from Exterior. Scale: 1/4" = 1'

Frame Size : 33 1/4 X 55 1/4
 W-5500 Clad Double Hung, Auralast Pine,
 Luxury Bronze Exterior,
 Interior-Paint Perfect White/M64EXW31123,
 No Drip Cap/No Nail Fin,
 4 9/16 Jamb,
 Standard Double Hung, Window Opening Control Device (4" open)
 ASTM Compl White Jambliner, Concealed Jambliner
 Oil Rubbed Bronze Hardware,
 US National-WDMA/ASTM, PG 35,
 Insulated SunResist Annealed Glass, Protective Film, Black Spacer,
 Argon Filled, Traditional Glz Bd,
 Luxury Bronze SDL, 7/8" Putty SDL w/Perm Wood Putty Int BAR,
 Light Bronze Shadow Bar, Colonial Top Lite(s) Only 3 Wide 2 High
 Top,
 BetterVue Mesh Luxury Bronze Screen,
 Product Does Not Qualify for Accidental Glass Breakage Warranty
 Coverage, *Custom-Width*, *Custom-Height*, IGTick=0.698(3/32 /
 3/32),(To Calculate True Window or Patio Door Depth Add 1-1/4" To
 Specified Jamb Width).
 - WOCD must be disengaged to reach full clear opening
 U-Factor: 0.30, SHGC: 0.18, VLT: 0.42, Energy Rating: 12.00, CPD:
 JEL-N-880-03888-00001
 PEV 2023.4.0.4526/PDV 7.271 (12/01/23) CW

2

LINE NO.	LOCATION SIZE INFO	BOOK CODE DESCRIPTION	QTY
----------	-----------------------	--------------------------	-----

Line-18 2ND FL
Rough Opening: 24 X 46

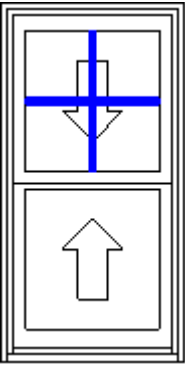

Viewed from Exterior. Scale: 1/2" = 1'

Frame Size : 23 1/4 X 45 1/4
W-5500 Clad Double Hung, Auralast Pine,
Luxury Bronze Exterior,
Interior-Paint Perfect White/M64EXW31123,
No Drip Cap/No Nail Fin,
4 9/16 Jamb,
Standard Double Hung, Window Opening Control Device (4" open)
ASTM Compl White Jambliner, Concealed Jambliner
Oil Rubbed Bronze Hardware,
US National-WDMA/ASTM, PG 35,
Insulated SunResist Annealed Glass, Protective Film, Black Spacer,
Argon Filled, Traditional Glz Bd,
Luxury Bronze SDL, 7/8" Putty SDL w/Perm Wood Putty Int BAR,
Light Bronze Shadow Bar, Colonial Top Lite(s) Only 2 Wide 2 High
Top,
BetterVue Mesh Luxury Bronze Screen,
Product Does Not Qualify for Accidental Glass Breakage Warranty
Coverage, *Custom-Width*, *Custom-Height*, IGThick=0.698(3/32 /
3/32),(To Calculate True Window or Patio Door Depth Add 1-1/4" To
Specified Jamb Width).
- WOCD must be disengaged to reach full clear opening
U-Factor: 0.30, SHGC: 0.18, VLT: 0.42, Energy Rating: 12.00, CPD:
JEL-N-880-03888-00001
PEV 2023.4.0.4526/PDV 7.271 (12/01/23) CW

2

Line-19 2ND FL
Rough Opening: 42 X 46

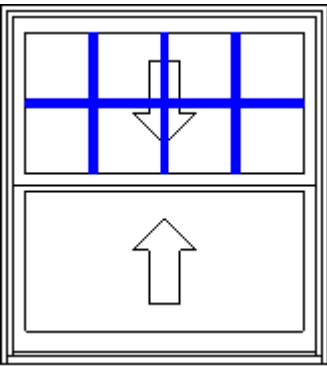

Viewed from Exterior. Scale: 1/2" = 1'

Frame Size : 41 1/4 X 45 1/4
W-5500 Clad Double Hung, Auralast Pine,
Luxury Bronze Exterior,
Interior-Paint Perfect White/M64EXW31123,
No Drip Cap/No Nail Fin,
4 9/16 Jamb,
Standard Double Hung, Window Opening Control Device (4" open)
ASTM Compl White Jambliner, Concealed Jambliner
Oil Rubbed Bronze Hardware,
US National-WDMA/ASTM, PG 35,
Insulated SunResist Annealed Glass, Protective Film, Black Spacer,
Argon Filled, Traditional Glz Bd,
Luxury Bronze SDL, 7/8" Putty SDL w/Perm Wood Putty Int BAR,
Light Bronze Shadow Bar, Colonial Top Lite(s) Only 4 Wide 2 High
Top,
BetterVue Mesh Luxury Bronze Screen,
Product Does Not Qualify for Accidental Glass Breakage Warranty
Coverage, *Custom-Width*, *Custom-Height*, IGThick=0.698(3/32 /
3/32),(To Calculate True Window or Patio Door Depth Add 1-1/4" To
Specified Jamb Width).
- WOCD must be disengaged to reach full clear opening
U-Factor: 0.30, SHGC: 0.18, VLT: 0.42, Energy Rating: 12.00, CPD:
JEL-N-880-03888-00001
PEV 2023.4.0.4526/PDV 7.271 (12/01/23) CW

1

LINE NO.	LOCATION SIZE INFO	BOOK CODE DESCRIPTION	QTY
----------	-----------------------	--------------------------	-----

Line-20 2ND FL
Rough Opening: 33 X 55 3/4

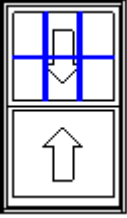

Viewed from Exterior. Scale: 1/4" = 1'

Frame Size : 32 1/4 X 55
W-5500 Clad Double Hung, Auralast Pine,
Luxury Bronze Exterior,
Interior-Paint Perfect White/M64EXW31123,
No Drip Cap/No Nail Fin,
4 9/16 Jamb,
Standard Double Hung, Window Opening Control Device (4" open)
ASTM Compl White Jambliner, Concealed Jambliner
Oil Rubbed Bronze Hardware,
US National-WDMA/ASTM, PG 35,
Insulated SunResist Annealed Glass, Protective Film, Black Spacer,
Argon Filled, Traditional Glz Bd,
Luxury Bronze SDL, 7/8" Putty SDL w/Perm Wood Putty Int BAR,
Light Bronze Shadow Bar, Colonial Top Lite(s) Only 3 Wide 2 High
Top,
BetterVue Mesh Luxury Bronze Screen,
Product Does Not Qualify for Accidental Glass Breakage Warranty
Coverage, *Custom-Width*, *Custom-Height*, IGThick=0.698(3/32 /
3/32),(To Calculate True Window or Patio Door Depth Add 1-1/4" To
Specified Jamb Width).
- WOCD must be disengaged to reach full clear opening
U-Factor: 0.30, SHGC: 0.18, VLT: 0.42, Energy Rating: 12.00, CPD:
JEL-N-880-03888-00001
PEV 2023.4.0.4526/PDV 7.271 (12/01/23) CW

2

Line-21 2ND FL
Rough Opening: 26 1/4 X 65 3/4

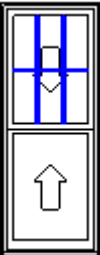

Viewed from Exterior. Scale: 1/4" = 1'

Frame Size : 25 1/2 X 65
W-5500 Clad Double Hung, Auralast Pine,
Luxury Bronze Exterior,
Interior-Paint Perfect White/M64EXW31123,
No Drip Cap/No Nail Fin,
4 9/16 Jamb,
Standard Double Hung, Window Opening Control Device (4" open)
ASTM Compl White Jambliner, Concealed Jambliner
Oil Rubbed Bronze Hardware,
US National-WDMA/ASTM, PG 35,
Insulated SunResist Annealed Glass, Protective Film, Black Spacer,
Argon Filled, Traditional Glz Bd,
Luxury Bronze SDL, 7/8" Putty SDL w/Perm Wood Putty Int BAR,
Light Bronze Shadow Bar, Colonial Top Lite(s) Only 3 Wide 2 High
Top,
BetterVue Mesh Luxury Bronze Screen,
Product Does Not Qualify for Accidental Glass Breakage Warranty
Coverage, *Custom-Width*, *Custom-Height*, IGThick=0.698(3/32 /
3/32),(To Calculate True Window or Patio Door Depth Add 1-1/4" To
Specified Jamb Width).
- WOCD must be disengaged to reach full clear opening
U-Factor: 0.30, SHGC: 0.18, VLT: 0.42, Energy Rating: 12.00, CPD:
JEL-N-880-03888-00001
PEV 2023.4.0.4526/PDV 7.271 (12/01/23) CW

2

LINE NO.	LOCATION SIZE INFO	BOOK CODE DESCRIPTION	QTY
----------	-----------------------	--------------------------	-----

Line-22 1ST FL BATH TEMP/OBS

Rough Opening: 24 X 28 3/4

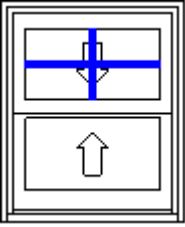

Viewed from Exterior. Scale: 1/2" = 1'

Frame Size : 23 1/4 X 28
 W-5500 Clad Double Hung, Auralast Pine,
 Luxury Bronze Exterior,
 Interior-Paint Perfect White/M64EXW31123,
 No Drip Cap/No Nail Fin,
 4 9/16 Jamb,
 Standard Double Hung, Window Opening Control Device (4" open)
 ASTM Compl White Jambliner, Concealed Jambliner
 Oil Rubbed Bronze Hardware,
 US National-WDMA/ASTM, PG 35,
 Insulated SunResist Tempered Glass, Protective Film, Black Spacer,
 Argon Filled, Traditional Glz Bd,
 Luxury Bronze SDL, 7/8" Putty SDL w/Perm Wood Putty Int BAR,
 Light Bronze Shadow Bar, Colonial Top Lite(s) Only 2 Wide 2 High
 Top,
 BetterVue Mesh Luxury Bronze Screen,
 Product Warranty Covers Accidental* Glass Breakage *Refer to the
 JELD-WEN warranty for additional information, *Custom-Width*,
 Custom-Height, IGThick=0.726(1/8 / 1/8),(To Calculate True
 Window or Patio Door Depth Add 1-1/4" To Specified Jamb Width).
 - WOCD must be disengaged to reach full clear opening
 U-Factor: 0.30, SHGC: 0.18, VLT: 0.41, Energy Rating: 12.00, CPD:
 JEL-N-880-04003-00001
 PEV 2023.3.0.4442/PDV 7.191 (09/06/23) CW

1

Line-23 BATH TEMP/OBS

Rough Opening: 32 X 44 1/2

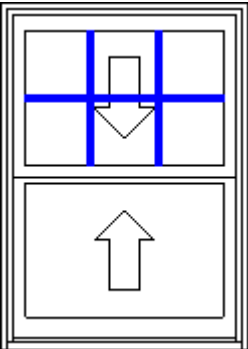

Viewed from Exterior. Scale: 1/2" = 1'

Frame Size : 31 1/4 X 43 3/4
 W-5500 Clad Double Hung, Auralast Pine,
 Luxury Bronze Exterior,
 Interior-Paint Perfect White/M64EXW31123,
 No Drip Cap/No Nail Fin,
 4 9/16 Jamb,
 Standard Double Hung, Window Opening Control Device (4" open)
 ASTM Compl White Jambliner, Concealed Jambliner
 Oil Rubbed Bronze Hardware,
 US National-WDMA/ASTM, PG 35,
 Insulated SunResist Tempered Glass, Protective Film, Black Spacer,
 Argon Filled, Traditional Glz Bd,
 Luxury Bronze SDL, 7/8" Putty SDL w/Perm Wood Putty Int BAR,
 Light Bronze Shadow Bar, Colonial Top Lite(s) Only 3 Wide 2 High
 Top,
 BetterVue Mesh Luxury Bronze Screen,
 Product Warranty Covers Accidental* Glass Breakage *Refer to the
 JELD-WEN warranty for additional information, *Custom-Width*,
 Custom-Height, IGThick=0.726(1/8 / 1/8),(To Calculate True
 Window or Patio Door Depth Add 1-1/4" To Specified Jamb Width).
 - WOCD must be disengaged to reach full clear opening
 U-Factor: 0.30, SHGC: 0.18, VLT: 0.41, Energy Rating: 12.00, CPD:
 JEL-N-880-04003-00001
 PEV 2023.3.0.4442/PDV 7.191 (09/06/23) CW

1

Total Units: 33

Note:

- * STORE & CUSTOMER MUST VERIFY THAT QUOTED WINDOWS MEET ALL LOCAL REQUIREMENTS
- * VERIFY ALL SIZES, COLORS, FRAME TYPES AND GLASS ARE CORRECT
- * DISCUSS ALL DELIVERY OPTIONS PRIOR TO THE SALES
- * BEFORE PRICE QUOTE IS GIVEN, STORE MUST E-MAIL APPROVAL THAT ALL SPECS ARE CORRECT
- * PROJECTS OVER \$100k WILL REQUIRE THE SPEC SHEET TO BE SIGNED OFF BY THE CUSTOMER AND STORE

CUSTOMER SIGNATURE:



Window & Patio Door Limited Warranty

OUR WARRANTY TO YOU...

JELD-WEN® Products¹ are designed to create lasting value for your home. This warranty is effective for all JELD-WEN window and patio door Products (except United Collection products) manufactured on or after **June 1, 2019** for use in the United States and Canada. Any previous warranties will continue to apply to products manufactured by JELD-WEN prior to this date. For additional information, including care and maintenance instructions, installation instructions, and previous warranties, refer to www.jeld-wen.com or www.jeld-wen.ca.

WHAT THIS WARRANTY COVERS

Except as set forth in the Special Coverages section below, we warrant that if your JELD-WEN Product exhibits a defect in material or workmanship within the time periods from the date of manufacture as specified below, we will, at our option, repair, replace or refund the purchase price of the Product or component part. Skilled labor² (where deemed necessary by us) to repair or replace any component is provided as specified below.

	Wood & Metal Clad Wood	Composite	Vinyl & Metal Clad Vinyl	Aluminum
Basic Product Coverage Owner-Occupied Single-Family Residence	20 years	10 years; glass is covered for 20 years	as long as you own and occupy your residence	10 years
Basic Product Coverage Commercial (Other than Owner-Occupied Single-Family Residence)	20 years	10 years	10 years	2 years
Skilled Labor² Coverage	2 years	2 years	2 years	1 year
Transferability - the maximum length of any coverage when you sell your residence or it becomes occupied by other than the original owner	10 years	10 years	10 years	Non-transferable

Special Coverages (Applies to both Owner-Occupied and Commercial)

The following Special Coverages apply to special product features and options; not all options are available on all products or in all regions.

Glass Options	Coverage	Notes
Triple-Glazed Glass Units	20 years	Includes the glass panes and the insulating seal.
ImpactGard® Glass Units	10 years	
Special Glazings	5 years	Includes laminated glass units other than ImpactGard, and glass options not listed in our product literature, e.g., leaded or decorative glass.
Blinds/Shades Between the Glass	10 years	Includes the seal, external control mechanism, and operation of the shade/blind.
Stress Cracks	1 year	Applies to sealed glass units installed in windows and patio doors. Laminated glass and special glazings are excluded. Coverage includes replacement glass and skilled labor ² necessary to replace the glass. Stress cracks occur when, in the first year after manufacture, the glass develops a crack without sign of impact.
Accidental Glass Breakage	Same as the Basic Product Coverage above (Owner-Occupied or Commercial)	Applies to Products ordered with double-strength or thicker glass. Not covered: damage attributable to acts of nature (e.g. fire, hurricane, etc.), civil disorder, building settling, structural failures of walls or foundations or improper installation, construction job-site mishaps, storage, or handling. Special glazings and ImpactGard glass are not covered by this glass breakage warranty.

Continued on next page

Special Coverages (continued)

Finish Options	Coverage	Notes
Finish on Metal Clad Exteriors	AAMA 2605: 30 years AAMA 2603/2604: 10 years Anodized: 5 years	Coverage is for peeling, checking, cracking, or exhibiting excessive chalk, fade or color change ¹ . Clad products installed within one mile of a salt-water source (for example, an ocean or salt lake) or other corrosive environment require additional and specific maintenance requirements. Refer to our full care and maintenance instructions.
Factory Interior Finish on Wood Products	1 year	Coverage is for peeling, checking, or cracking. Should the factory interior finish be proven defective within this time period, we will at our option, replace or refinish the component or product, or offer a refinish credit up to \$50 per opening for windows or \$100 per opening for patio doors. This coverage applies to factory-applied finish coat options only; standard factory-applied primer is not a finish coat.
Colored and Laminated Surfaces on Vinyl and Composite Products	10 years	Coverage is for peeling, blistering, or flaking, and excessive color change ³ . This coverage does not extend to discoloration, polish, surface damage, or alteration caused by the use of natural or chemical solvents or an environmental factor causing such damage.
Other Special Coverages	Coverage	Notes
Auralast® Protection for Wood Products	Owner-Occupied Single-Family Residence: as long as you own and occupy your residence	Coverage is for wood decay and/or termite damage in pine wood components. Warranty coverage outside Canada, the contiguous 48 states and Alaska is contingent upon approval from the JELD-WEN Customer Care Department. Please contact us.
	Commercial: 20 years	
Custom Fiberglass Door Slabs	As long as you own and occupy your residence	
Factory Prefinish on Custom Fiberglass Doors	10 years	Should the factory prefinish be proven defective, we will at our option refinish the door or pay up to \$350.00 per opening to the current owner.
Electric Operators	1 year	Coverage includes replacement parts and skilled labor necessary to replace the operator for one year.
Retractable Roll Screens	5 years	

HOW TO GET ASSISTANCE

If you have a problem with your JELD-WEN Product, contact the dealer/distributor or contractor from whom you purchased your product or contact us directly:

	In the United States:	In Eastern Canada:	In Western Canada:	In Ontario Canada:
Mail:	JELD-WEN Customer Care Attn: Warranty Claims P.O. Box 1329 Klamath Falls, OR 97601	JELD-WEN Service Dept 90, rue Industrielle Saint-Apollinaire, Quebec, Canada G0S 2E0	JELD-WEN Service Dept 550 Munroe Avenue Winnipeg, Manitoba, Canada R2K 4H3	JELD-WEN Service Dept 90 Stone Ridge Road Vaughan, Ontario Canada L4H 3G9
Phone:	888-JWHelpU 888-594-3578	800-463-1930	888-945-5627 204-668-8230	800-440-2714 905-265-5700
Fax:	800-436-5954	888-998-1599	204-663-1072	905-265-5704
E-mail:	jeldwenwarranty@jeld-wen.com		wpgservice@jeld-wen.com	
Web:	www.jeld-wen.com/contact-us		www.jeld-wen.ca/contact-us	

We can respond quickly and efficiently if you provide the following: a) product identification (from the original order/invoice, spacer code, permanent label, or the window identification number found on corner of glass), b) how to contact you, c) the address where the product can be inspected, and d) a description of the apparent problem and the product (photographs are helpful).

What We Will Do...

Upon receiving your notification, we will send out an acknowledgement within three business days to the contact, which you have provided. We will investigate your claim and will begin to take appropriate action within 30 days after receipt of notification. If your warranty claim is denied, we may charge an inspection fee for an onsite inspection that is required or requested by you.

Continued on next page

HOW TO GET ASSISTANCE (CONTINUED)

If your claim is approved, and we choose to repair or replace the product or a component of the product, the replacement product/component will be provided in the same specification as the original product or its nearest equivalent current product. Replacement components/products are warranted for the balance of the original product warranty or 90 days, whichever is longer.

Product Purchase Date: _____
Order Number: _____

If the claimed nonconformity is warp of a door slab, we may defer repairing or replacing the door slab for a period up to twelve (12) months from the date of claim. It is not uncommon for a temporary warp condition to occur as the door slab adjusts to local humidity and temperature conditions. This deferral will not be counted against the warranty period.

WHAT THIS WARRANTY DOES NOT COVER

JELD-WEN is not liable for damage, product failure or poor product performance due to:

- Normal wear and tear, including normal wear and tear of weatherstrip; natural weathering of surfaces. Variance in color or texture of natural wood parts, and natural tarnishing of copper cladding are not considered defects.
- Normal wear and tear to hardware and naturally occurring changes to hardware finishes (e.g., corrosion or tarnishing).
- Exposure to chemicals (e.g. brick wash) or a harsh environment (e.g. salt spray or airborne pollutants) unless otherwise stated above.
- Misuse, abuse or failure to properly finish and provide maintenance.
- Alteration or modification of the Product (e.g. customer applied tints or films, paint finishes, security systems).
- Any cause beyond the reasonable control of JELD-WEN (e.g. fire, flood, earthquake, other acts of nature, and acts of third parties outside of our control).
- Failure to provide an adequate overhang for fiberglass doors; damage caused by extreme temperature buildup where storm doors are present. For general guidelines, see our "Appropriate Protection for Exterior Doors" in our product literature or at www.jeld-wen.com/ resources; for specific information pertaining to your structure, consult your contractor or other building professional.
- Improper installation not in conformance with JELD-WEN installation instructions (note: see www.jeld-wen.com for current installation instructions); operational problems and problems related to water and/or air infiltration/leaking as a result of improper installation or flaws in building design or construction.
- Installation into a condition that exceeds product design standards and/or certified performance specifications and/or is not in compliance with building codes.
- Extreme artificial temperature buildup or exposure (e.g., where storm doors/windows are present).
- Hardware or inserts that are not provided by us, such as locksets, door handles, strikes, etc.
- Condensation or damage as a result of condensation (Note: unless due to insulating glass failure, most condensation problems are related to excessive humidity levels in a structure. Contact a heating/air conditioning specialist for help).

- Wood decay in wood components other than of pine species and any components (including pine) that come in direct contact with soil. Note: superficial mold/mildew does not indicate wood decay.

JELD-WEN is also not liable for:

- Glass breakage (except as specifically covered above).
- Screen damage due to normal wear and tear, misuse, abuse, or insect or animal activity.
- Slight expansion or contraction of product components due to varying environmental conditions; slab movement (shrinkage or swelling) of 1/4" or less due to temperature and humidity, consult the Homeowner's Manual on how to work with this natural movement.
- Slight imperfections or wavy distortions in the glass that don't impair structural integrity. Note: wavy distortions in the glass (e.g. related to laminate interlayer or heat strengthening of glass) are not considered a defect. Slight color variations in glass are not considered a defect.
- Hairline cracks in factory-applied finishes; surface cracks that do not compromise the underlying material are not a defect.
- Damage or distortion to other property, including but not limited to, vinyl siding, building components or landscaping caused in whole or in part by reflection of light or heat from JELD-WEN windows or doors.
- Product or component performance decline due to aging, inert gas dissipation, natural processes or failure to provide proper maintenance. Note: Other than inert gas loss due to seal failure, the migration of an inert gas, such as argon, is a natural process that occurs over time and is not a defect.
- Repairs on product not accessible by road; travel costs related to repairs on product located more than 125 miles/200 kilometers from an authorized dealer; providing, assembling, or dismantling scaffolding, lifts, or other specialized equipment.
- Labor and materials for repainting or refinishing activities or the removal or disposal of defective product(s); labor exceeding the time periods specified above.
- Incidental or consequential damage. Some states/provinces do not allow the exclusion or limitation of incidental or consequential damages, so this may not apply to you.

Continued on next page

Important Legal Information -- Please read this carefully. It affects your rights.

This Limited Warranty document sets forth our maximum liability for our products. We shall not be liable for special, indirect, consequential, or incidental damages. Your sole and exclusive remedy with respect to any and all losses or damages resulting from any cause whatsoever shall be as specified above. We make no other warranty or guarantee, either express or implied, including implied warranties of merchantability and fitness for a particular purpose to the original purchaser or to any subsequent user of the Product, except as expressly contained herein. In the event state or provincial law precludes exclusion or limitation of implied warranties, the duration of any such warranties shall be no longer than, and the time and manner of presenting any claim thereon shall be the same as, that provided in the express warranty stated herein. This Limited Warranty document gives you specific legal rights, and you may have other rights that vary from state/province to state/province.

Any dispute, controversy or claim arising out of or relating to this warranty, any alleged breach thereof, or the use or sale of the products to which this warranty applies shall be resolved by mandatory and binding arbitration administered by the American Arbitration Association in accordance with its commercial arbitration rules. Any ensuing arbitration will be venued in Charlotte, North Carolina. Original purchaser agrees that they may assert claims against JELD-WEN in their individual capacity only, and not as a plaintiff or class member in any purported class action proceeding. This warranty shall be interpreted in accordance with the laws of North Carolina (excluding North Carolina's conflict of laws principles). If any provision of this warranty is deemed illegal or unenforceable in a judicial proceeding, that provision shall be severed and excluded, and the remainder of this warranty shall continue in force. Rejection of these dispute resolution provisions must be sent to JELD-WEN at the address provided herein within thirty (30) days of original purchaser's receipt of the Products to which this warranty applies.

No distributor, dealer or representative of JELD-WEN has the authority to change, modify or expand this warranty. The original purchaser of this Product acknowledges that they have read this warranty, understand it and are bound by its terms and agrees to provide this warranty to the original owner of the structure into which the Product is installed.

¹ "JELD-WEN Products" shall refer to window and patio door products (except United Collection products) manufactured in the United States and/or Canada and marketed under the JELD-WEN brand name for use in the United States and/or Canada. See our separate United Collection warranty, or our Export Warranty for applicable coverage on products used outside the United States and Canada.

² "Skilled labor" refers to tasks where specialized technical knowledge, experience, methods or tools are required to properly identify, diagnose and/or correct product-related issues.

³ "Chalking" of the exterior finish is not a defect unless it exceeds a numerical rating of eight (8) when measured in accordance with the standard procedures specified in ASTM D4214. Fading or changing in color of the exterior finish is not a defect unless it exceeds five (5) E units, calculated in accordance with ASTM D2244, paragraph 6.2. Color change shall be measured on an exposed area of finish that has been cleaned of surface soils and chalk, and the corresponding values measured on the original or unexposed area of finish. Fading or color changes may not be uniform if the surfaces are not equally exposed to the sun and elements. If the above ASTM standards change, the standard in effect at the time of purchase applies. As an option to replacement, we may choose to refinish the product.

© 2019 JELD-WEN, inc. | JELD-WEN, AuraLast, and ImpactGard are registered trademarks of JELD-WEN, inc.

1624 EDISON - WINDOW LOCATIONS



Line 1

Line 6

Line 14

Line 12

Line 9

Line 16

Line 8

Line 22



Line 21

Line 20

Line 11

Line 19

Line 7



Line 1

Line 6

Line 5

Line 12

Line 14

Line 13



Line 3

Line 5

Line 4

Line 13

Line 18



Line 10

Line 23



Line 8

Line 15

Line 10

Line 17

Line 23



2014-04-27

A full steel-edge perimeter offers additional strength and a higher security rating. Reinforced lock area offers more screw-holding power than wood. Engineered to resist cracking, splitting, warping, or rotting.



Front door with security door
36x80

Door will be painted to meet historical color combinations



Side door with security door
32x80.

Door will be painted to meet historical color combinations



Rear door with security door.
36x80.

Door will be painted to meet historical color combinations

Fire Listings, Matrix of Approvals & Limits of Use

Max Size Allowed	Limitations	Max Hourly Rating	Neutral or Positive Pressure	Maximum Glass Size Allowed	Single, Pairs or Double Egress
3'0" x 7'0"	Unit, Mortise, or Cylindrical Latches/Deadbolts max 2 3/4" backset, door bottoms, thresholds.	20 Minutes	Neutral Pressure	792 square inches	Single Only
3'0" x 7'0"	Unit, Mortise, or Cylindrical Latches/Deadbolts max 2 3/4" backset, Mortise Exit Devices/Surface mounted Vertical Rod Fire Exit Devices, RIM Type Fire Exit Devices/Surface Mounted Closers, door bottoms, thresholds.	90 Minutes	Neutral Pressure	100 square inches	Single Only
3'0" x 7'0"	Unit, Mortise, or Cylindrical Latches/Deadbolts max 2 3/4" backset, Mortise Exit Devices/Surface mounted Vertical Rod Fire Exit Devices, RIM Type Fire Exit Devices/Surface Mounted Closers, door bottoms, thresholds.	20 Minutes	Neutral Pressure	792 square inches	Single Only
3'6" x 7'0"	Unit, Mortise, or Cylindrical Latches/Deadbolts max 5" backset, Mortise Exit Devices/Surface mounted Vertical Rod Fire Exit Devices, RIM Type Fire Exit Devices/Surface Mounted Closers, door bottoms, thresholds.	90 Minutes	Positive Pressure	100 square inches	Single Only
3'0" x 8'0"	Unit, Mortise, or Cylindrical Latches/Deadbolts max 2 3/4" backset, Mortise Exit Devices/Surface mounted Vertical Rod Fire Exit Devices, RIM Type Fire Exit Devices/Surface Mounted Closers, door bottoms, thresholds.	20 Minutes	Neutral Pressure	792 square inches	Single Only
3'0" x 8'0"	Unit, Mortise, or Cylindrical Latches/Deadbolts max 2 3/4" backset, Mortise Exit Devices/Surface mounted Vertical Rod Fire Exit Devices, RIM Type Fire Exit Devices/Surface Mounted Closers, door bottoms, thresholds.	90 Minutes	Neutral Pressure & Positive Pressure	100 square inches	Single Only
4'0" x 8'0"	20 Gauge Only, Unit, Mortise, or Cylindrical Latches/Deadbolts max 2 3/4" backset, Mortise Exit Devices/Surface mounted Vertical Rod Fire Exit Devices, RIM Type Fire Exit Devices/Surface Mounted Closers, door bottoms, thresholds.	90 Minutes	Positive Pressure	100 square inches	Single Only

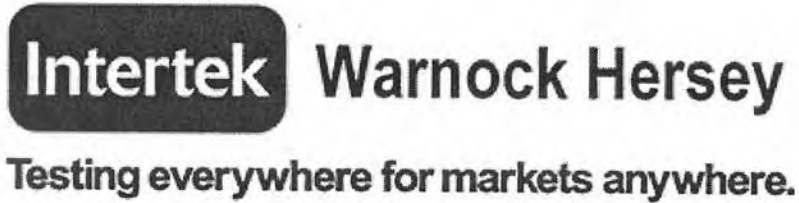

LISTING INFORMATION OF Durador 20-90 Min Hollow Metal Fire Door

SPEC ID: 8899

Taylor Building Products
631 North 1st Street
P O Box 457
West Branch, MI 48661

This report is for the exclusive use of Intertek's Client and is provided pursuant to the agreement between Intertek and its Client. Intertek's responsibility and liability are limited to the terms and conditions of the agreement. Intertek assumes no liability to any party, other than to the Client in accordance with the agreement, for any loss, expense or damage occasioned by the use of this report. Only the Client is authorized to copy or distribute this report and then only in its entirety. Any use of the Intertek name or one of its marks for the sale or advertisement of the tested material, product or service must first be approved in writing by Intertek. The observations and test results in this report are relevant only to the sample tested. This report by itself does not imply that the material, product, or service is or has ever been under an Intertek certification program. To verify a listing, call 888-347-5478, or check our searchable online Directory of Listed Products at www.intertek.com.

NEUTRAL PRESSURE DOORS

Durador Hollow Metal Type (18, 24, 26 gauge) (Steel-Faced) (Foam-Filled), Swinging, Embossed Design Fire Door for installation in single swing 20 minute to 3/4 hour locations.

Limitations

Unit, Mortise or Cylindrical Latches/Deadbolts/Door Bottoms/Thresholds/4" x 4" x 0.098" Hinges.

Maximum Size

SINGLE SWING 3'-0" wide x 6'-8" high

Durador Hollow Metal Type (24 gauge) (Foam-filled) Swinging Embossed or Flush Design Fire Doors for installation singly in 20 minute locations

Limitations

Unit, Mortise or Cylindrical Latches with up to 2-3/4" backset/Lights - up to 792 sq. in.

Maximum Size

SINGLE SWING 3'-0" wide x 7'-0" high
STANDARD PAIRS Not Allowed

Durador Hollow Metal Type (24 gauge) (Foam-filled) Swinging Embossed or Flush Design Fire Doors for installation singly in 20 minute locations with no hose stream.

Limitations

Unit, Mortise or Cylindrical Latches with up to 2-3/4" backset/Lights - up to 792 sq.in.

Maximum Size

SINGLES 3'-0" wide x 7'-0" high
PAIRS Not Allowed

*Manufacturer's Designation

Durador Steel-Faced (22, 24 gauge) (Urethane Core Type) Swinging Flush Door for installation in 1-1/2 hour locations. For use in listed 3-sided frames as per frame manufacturer's listing(s)

Limitations*

Mortise or Cylindrical Latches with maximum 2-3/4" backset/Mortised Exit devices/Surface

Mounted Vertical Rod Fire Exit Devices/Rim Type Fire Exit Devices/Deadbolts/Surface Mounted Closers/Surface Mounted Protection Plates/Viewer/Vision Light Kit - Maximum 792 sq.in (1/3, 3/4 hour) or 100 sq.in. (1, 1-1/2 hour)/Gasketing - listed and labeled for opening.

Maximum Size

SINGLE SWING 3'-0" wide x 7'-0" high
STANDARD PAIRS Not Allowed
DOUBLE EGRESS PAIRS Not Allowed

* See Manufacturer's installation instructions for additional information on size restrictions and limitations

ADDITIONAL LISTEE

PERMA-DOOR

Evaluated to the following...

Unless otherwise noted, assemblies in this section have been evaluated for conformance to the following standards:

ASTM-E152, Methods of Fire Tests of Door Assemblies
CSFM-43.7, Methods of Fire Tests of Door Assemblies
CAN4-S104(ULC-S104), Standard Method for Fire Tests of Door Assemblies
NFPA-252, Standard Methods for Fire Tests of Door Assemblies
UBC-7-2-94, Uniform Building Code
UL-10(b), Fire Tests of Door Assemblies

and are installed in accordance with the following:

NFPA-80, Fire Doors and Windows

Manufacturer's Instructions

All assemblies are identified by a label or marking bearing the wording, "Listed (Product)", a time interval, temperature rise (if applicable), a serial number and the WHI Certification Mark.

(Unless otherwise specified, all Fire Doors have a nominal thickness of 1-3/4".)

CATEGORY B DOOR POSITIVE PRESSURE

Durador Steel-Faced (22, 24 gauge) (Urethane Core) (Simulated Panel or Flush Type) Swinging Flush Door for installation in up to 90 minute (without hose stream) locations. For use in any "Category C - Standard frame. These doors may also be installed in frames listed in "Category C - Proprietary" in accordance with the frame manufacturer's individual listing. A field-applied edge seal system is required. Refer to the individual manufacturer's Category G listing for limitations.

Limitations*

Mortise or Cylindrical Latches with maximum 5" Backset/Mortised Exit Devices/Surface Mounted Vertical Rod Fire Exit Devices/Rim-Type Fire Exit Devices/Deadbolts/Surface-Mounted Closers/Viewer/Surface-Mounted Door Bottoms. Temperature Rise - 650°F at 30 minutes.

MAXIMUM SIZE

SINGLE SWING 3'-6" wide x 7'-0" high
 STANDARD PAIRS Not Allowed
 DOUBLE EGRESS PAIRS Not Allowed

*See manufacturer's installation instructions for additional information on Smoke and Draft Control, size restrictions and limitations.

Testing Standards: UBC-7-2-97/UL-10C (Positive Pressure).

Evaluated to the following...

This category includes doors evaluated with an edge-sealing system (Category G) field-applied to the labeled frame or door. The application of the edge-sealing system does not require any machining of the frame or door. Please refer to "Category G - Edge-Sealing System" for individual manufacturer's listings.

These assemblies are eligible for use in any "Category C - Standard" frame. These doors may also be installed in frames listed in "Category C - Proprietary" in the accordance with the frame manufacturer's individual listing.
 All doors listed in Category B are eligible to bear the "S" (for Smoke & Draft Control assemblies) if a listed "Category H - Smoke & Draft Control Gasket" has been applied to the assembly. Please refer to Category H for individual gasket manufacturer's listings.

All doors in this category are identified by a label or marking bearing the wording, "Listed Fire Door", a time interval, a temperature rise rating, a serial number and the Warnock Hersey Certification Mark and "UBC-7-2-97/UL 10C".

<u>Attribute</u>	<u>Value</u>
Architecture Code	08100 Metal Doors and Frames
Architecture Subcode	08110 Metal Doors
Client Number	14964
Criteria	NFPA-80
Criteria	NFPA 252 (1995)
Criteria	ASTM E152-81a
Criteria	CSFM-43.7
Criteria	CAN4-S104 (ULC-S104) (1985)

FN24S 30 68 RU4 FL 5/04/99

Other information that must be indicated on the top of the door. Closer reinforcement is optional. When it is provided, the door must then have a sticker on its top stating "CLOSER REINFORCEMENT IS PROVIDED".

DOORS COVERED:

Under Taylor Building Products: Taylor Door; Economy, DuraDoor, UniDoor, Regal; Perma Door; Economy, Simplicity, Royal, Regency

RATING AND SIZE (inches):

	Thickness	Maximum Width	Maximum Height
Single Swing, Flush and Embossed (1/3, 3/4, 1, and 1-1/2 Hour Ratings)	1-3/4 minus 1/16	36	96
Single Swing, Flush and Embossed (1/3 Hour without Hose Steam)	1-3/4 minus 1/16	42	84

HARDWARE

(Preparation for Installation)

Hinges: Per NFPA 80 or Minimum 4" by 4" by 0.097". Preparation is done during manufacture.

Latches: Only listed and labeled for use with rated openings. Any preparation must leave at least 1/2-inch wood surrounding hardware. Use hardware manufacturer's template. Minimum 1/2" bolt throw. Preparation for latches is done during manufacturing.

Cylindrical: 2-3/8" or 2-3/4" backset; Maximum bore 2-1/8"

Mortised: Maximum block cutout size 6.375" long by 4.00" deep by 1.00" wide (Maximum Tolerances: + 1/8 inch width / +1/4 inch depth / + 1/2 inch length (1/4 inch both ends) **For positive pressure applications:** Intumex intumescent must be applied behind the rosettes of all latches.

Dead Bolt (where permitted):

For Wood Lock Block: 2-3/8" or 2-3/4" inch backset; Maximum 2-1/8" bore; Dead lock bore a minimum 2-7/8" (or maximum 11") centerline dead lock to centerline cylindrical latch. Any preparation must leave at least 1/2-inch wood surrounding hardware.

For Alternative Standard or Universal Combination Lock Block: 2-3/8" or 2-3/4" inch backset; Maximum 2-1/8" bore; Dead lock bore a minimum 5-1/2" (or maximum 11") centerline dead lock to centerline cylindrical latch.

Fire Exit Hardware: Surface Mounted Vertical Rods; Rim Type Exit Device; or Mortise Type exit Device. Install Surface mounted hardware with through bolts unless reinforcement is provided.

Closers: Listed and labeled Surface Mounted Closers

Closer reinforcement is optional. When it is provided, the door must then have a sticker on its top stating "CLOSER

REINFORCEMENT IS PROVIDED". If closer reinforcement is not provided then install closers with through bolts.

Weatherstrip: Listed and labeled for rated opening

Kickplates: Protection plates of brass, bronze, steel, aluminum, polycarbonate, or decorative laminate may be applied with fully-threaded wood screws with a minimum size No. 6 by 3/4 inch, spaced a minimum 6 inch on center around the perimeter of the plate. The top of the plate shall be a maximum of 16 inches above the bottom of the door. Plates may be installed on one or both sides of the door.

Louvers: Not Allowed

Viewers: Listed and labeled for rated opening

Vision Panels: Listed and labeled for rated opening. Refer to Figure 2.

NEUTRAL PRESSURE ASSEMBLIES

Rating (Hours)	Maximum Visible Area (in ²)	Maximum Visible Width (inches)	Maximum Visible Height (inches)
1/3 & 3/4	792	22	36
1/3, 3/4 1 & 1-1/2	100	12	33

POSITIVE PRESSURE ASSEMBLIES

Rating (Hours)	Maximum Visible Area (in ²)	Maximum Visible Width (inches)	Maximum Visible Height (inches)
1/3, 3/4, 1 & 1-1/2	100	12	33

Cutouts for glazing must be a minimum of 6 inches from edge of cutout to door edge and/or any other cutout. All glazing must be listed. All glazing must be installed in accordance to the installation instructions from the glazing manufacturer. All limitations in the glazing listing are applicable.

An 18 gauge steel channel is required around the cutout of the vision panel.

FOR POSITIVE PRESSURE:

1/8 inch bead of PEMKO FG3000 around the perimeter of reinforcement.

PEMKO FG3000 shall be installed between listed and labeled glazing and listed and labeled light kit.

Door Bottoms: Doors are manufactured to receive a door bottom seal that slides into door bottom rail. Optional – Listed Surface Applied Door Bottom Seals.

CUTTING DOWN DOOR

Maximum height reduction of 4-inches, from the bottom only. Follow instructions found in Figure 5 of this specification.

CONVERSION OF DOOR FROM NEUTRAL PRESSURE TO POSITIVE PRESSURE:

Four (4) nominal 1/8" diameter rivets are used to attach face 'A' to face 'B'. Two Rivets are used on each vertical

door edge.

MARKING:

When all machining has been completed on the fire door, the Warnock Hersey () certification label may be applied within the top 1/3 of hinge stile. The certification label shall be applied with 1/8 inch diameter rivets or adhered door edge with adhesive if mylar.

Exception: When a continuous type hinge is applied to the fire door, the WH certification label shall be attached to the top of the door.

The certification label shall contain (at a minimum):

Warnock Hersey Certification Mark () with Country Identifiers ^[1]_[1]

The word "LISTED"

The product category "FIRE DOOR"

Fire Protection Rating

Serial Number

Listee's Name (If multiple plants, then location or location code shall be noted on label.)

The words "DO NOT REMOVE OR COVER THIS LABEL"

The words "SEE INSTALLATION INSTRUCTIONS"

OTHER ITEMS: ^[2]_[2]

POSITIVE PRESSURE statement:

If the door is to be labeled for positive pressure, the following is required.

Required: The words "MEETS UBC 7-2-97 / UL 10C"

Optional: "POSITIVE PRESSURE"

SMOKE AND DRAFT CONTROL statement:

Required: The label shall provide the required positive pressure statements (see positive pressure requirements above).

The **[S]** mark

The words "SMOKE AND DRAFT CONTROL RATING REQUIRE A LISTED GASKET."

Optional: The words "SMOKE LEAKAGE < 3 cfm/ft² per UL 1784"

TEMPERATURE RISE statement:

UBC Requirement:

If the door is labeled as meeting UBC requirements, then a temperature statement is required on each door.

Required: The words "TEMP RISE @ 30 MIN. > 650°F MAX"

WITHOUT HOSE STREAM

For door openings not requiring hose stream test, then the label will state "20 MINUTE WITHOUT HOSE STREAM" ^[3]_[3]

FIRE EXIT HARDWARE:

Per NFPA 80 2-4.4.2 any and all doors to be equipped with Fire Exit Hardware shall have the statement "FIRE DOOR TO BE EQUIPPED WITH FIRE EXIT HARDWARE"

If the fire door is to have Surface-Mounted Fire Exit Hardware (as defined in NFPA 80 1-3.4) then the label shall state "FIRE DOOR TO BE EQUIPPED WITH SURFACE-MOUNTED FIRE EXIT HARDWARE."

INSTALLATION INSTRUCTIONS:

FOR BOTH NEUTRAL PRESSURE AND POSITIVE PRESSURE DOORS:

Installation instructions shall be packaged with all fire doors bearing the Warnock Hersey certification mark. The instructions shall include specific information regarding the installation of fire doors, and reference NFPA 80, "Standard for Installation of Fire Doors and Windows". At least the following information shall be provided in all instructions:

Surface-mounted hardware must be attached with through-bolts unless reinforcements are provided.

A maximum 1/8" clearance between the frame and door is allowed.

FOR POSITIVE PRESSURE DOORS

Special, detailed instructions shall be provided when doors bear the label indicating compliance with UBC 7-2-1997 / UL10C.

OPTION 1:

Listed and Labeled (3-sided) 16 gauge steel frames meeting ANSI A155.1/UL63 or other listed frames PEMKO gasket S88 or equivalent Category "H" Smoke and Draft Control Gasket and PEMKO HSS2000 shall be surface applied to the frame rabbet, or any other listed and labeled intumescent seal and smoke and control gasket.

An 18 gauge steel reinforcement with $\frac{3}{4}$ inch legs required with a 1/8-inch bead of Pemko FG3000 around the perimeter of the reinforcement and Pemko FG3000 between listed and labeled glazing and listed and labeled light kit.

OPTION 2:

Listed and labeled (3-sided) 18/20/22 gauge steel frames, adjustable or fixed, with a 5/8 inch stop height and a kerf. (Refer to Figures 3 and 4.)

PEMKO gasket PK52 or equivalent Category "H" Smoke and Draft Control Gasket inserted into the kerf and PEMKO HSS2000 shall be surface applied to the frame rabbet, or any other listed and labeled intumescent seal and smoke and control gasket.

An 18 gauge steel reinforcement with $\frac{3}{4}$ inch legs required with a 1/8-inch bead of Pemko FG3000 around the perimeter of the reinforcement and Pemko FG3000 between listed and labeled glazing and listed and labeled light kit.

If the door assembly is to receive the **[S]** mark on the fire-rating label, a statement to the effect of the following shall be made in the installation instructions:

"Note: For **[S]** (smoke and draft control rating), a listed Category "H" Smoke and Draft Control Gasket shall be installed to the opening. "

OPTION 3 REQUIRED FOR 3'0" BY 8'0" (or smaller):

Listed and labeled (3-sided) 18/20/22 gauge steel frames, adjustable or fixed, with a 5/8 inch stop height. (Refer to Figures 3 and 4.)

PEMKO HSS2000xS88 applied to stop or National Guard Products model 9500 applied to rabbet with Pemko S88 applied to stop, as a Category "H" Smoke and Draft Control Gasket, or any other listed and labeled intumescent seal and smoke and control gasket.

An 18 gauge steel reinforcement with $\frac{3}{4}$ inch legs required with a 1/8-inch bead of Pemko FG3000 around the perimeter of the reinforcement and Pemko FG3000 between listed and labeled glazing and listed and labeled light kit.

[1] "C" for Canada and "US" for United States. For doors both identifiers may be used except when the doors are 20 Minute Without Hose Stream. Then the "US" identifier only shall be used.

[2] Depending on code requirements or test results, some additional labeling information will be required.

Machining Drawings (page 8 of 8)

Figure 8: Positive Pressure Rivet Locations

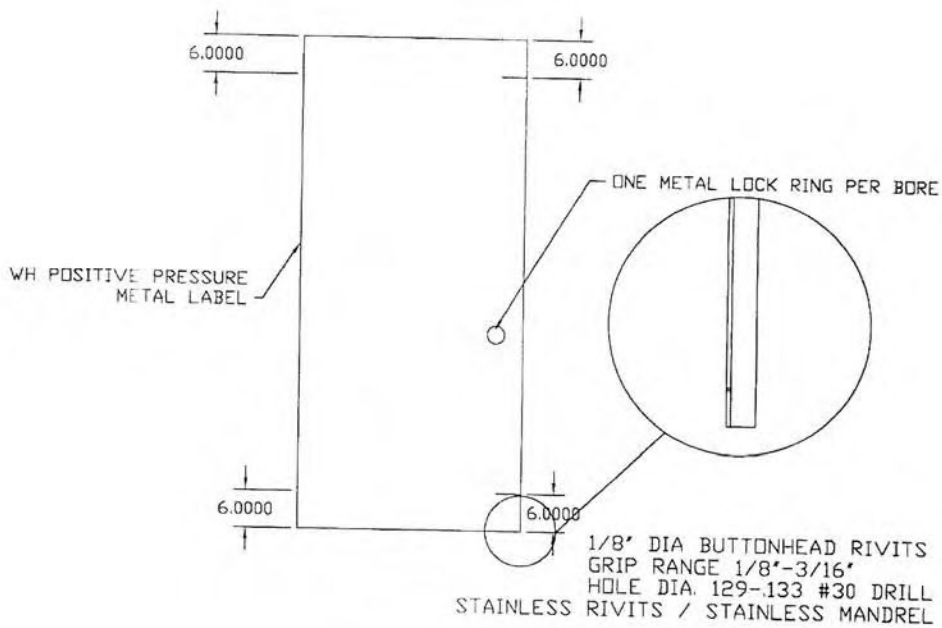

NO	DATE	DESCRIPTION	CHG	DATE	DESCRIPTION	MATERIAL

DRAWN		CHKD	FRACTION	DECIMAL	ALL	 631 N. FIRST ST. WEST BRANCH, MI 49661
MAM						
DATE						NAME
3/15/02						POSITIVE PRESSURE- RIVIT LOCTIONS
						TYPE
						DRAWING NUMBER

NOTE: INSTALLED ON ALL DOORS TO BE HUNG IN FIRE-RATED OPENINGS.

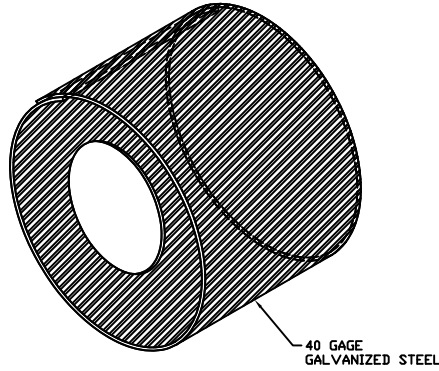

FORMED PART

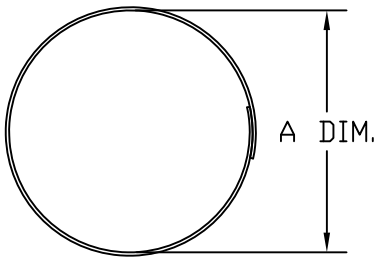

SIZE	A	B
1-5/8"	1.625	5.671
2-1/8"	2.125	7.562

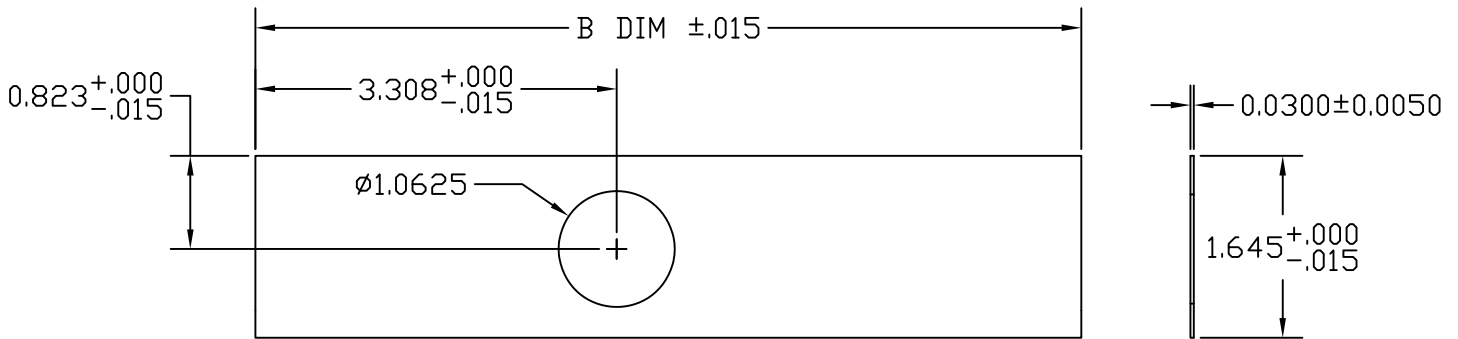

UNFORMED PART



METAL LOCK RING
DETAIL

DWG#	FIRE RING
DATE	11-25-14
NAME	KRB
SECTION	IX
PAGE	1

TAYLOR ENTRANCE SYSTEMS FIRE LABELS



90 Minute Mylar Neutral Pressure – 9YN – 53900040



90 Minute Metal Neutral Pressure – 9TN – 53900031



20 Minute Mylar Neutral Pressure – 2YN – 53900038



90 Minute Mylar Positive Pressure – 9YP – 53900044



90 Minute Metal Positive Pressure – 9TP - 599900045



**1-1/2 Hour (B)
MAXIMUM
FIRE RATING**

This Door
meets all
the requirements
of NFPA-252,
UL-10B

Fire Rating
cannot exceed
Fire Rating
of the wall
or frame.

(Single swing only)

Part # 53900041



**20 Min. (C)
MAXIMUM
FIRE RATING**

This Door
meets all
the requirements
of NFPA-252,
UL-10B

Fire Rating
cannot exceed
Fire Rating
of the wall
or frame.

(Single swing only)

Part # 53900050



AMERICA'S DOORMAKER

Taylor Entrance Systems STC & OITC Ratings Summary			
Description	ATI Test Report Number	STC	OITC
20 Gauge Steel Edge Door	M2914.05-113-11	21	25
20 Gauge Steel Edge Door with 1" I.G. Full Lite	M2914.06-113-11	28	25
22 Gauge Steel Edge Door	C1193.04-113-11	25	24
22 Gauge Steel Edge Door with 1" I.G. Full Lite	M2914.04-113-11	28	25
24 Gauge Steel Edge Door	C1193.05-113-11	22	23
24 Gauge Steel Edge Door with 1" I.G. Full Lite	M2914.02-113-11	25	24
25 Gauge Wood Edge Door	C1193.02-113-11	24	23
Fiberglass Door (Grand Marais)	C8441.01-113-11	25	24
Fiberglass Door (Timbergrain)	C1193.03-113-11	25	23

NOTES:

- 1) All testing conducted to the ASTM E90 test standard for Sound Transmission Loss.
- 2) For detailed information see test reports. Reports available upon request.
- 3) All results based on operable test units. Inoperable results available upon request.

2022 Energy Star® QUALIFYING UNITS MATRIX



AMERICA'S DOORMAKER

Smooth or Stainable Steel Doors (Steel Edge)	1/4 LITE				1/2 LITE		3/4 LITE			FULL LITE			SIDELITES			
Description -->	Craftsman	1/2 Rnd Top Lite	Center Lite	Twin Top Lite	1/2 Lite	Twin 1/2 Lite	3/4 Lite	Twin 3/4 Lite	3/4 oval	Full Lite	Twin Full Lite	Full Oval	1/2 Lite	3/4 Lite	Full Lite	
Unit qualifies with:																
Clear (IG)	.24 / .10	.24 / .10	.24 / .10	.24 / .10	.30 / .19	.30 / .19	.34 / .26	.34 / .26	.34 / .26	.38 / .34	.38 / .34	.38 / .34	.25 / .14	.29 / .19	.32 / .23	
Low-E	.22 / .09	.22 / .09	.22 / .09	.22 / .09	.26 / .16	.26 / .16	.28 / .21	.28 / .21	.28 / .21	.32 / .28	.32 / .28	.32 / .28	.23 / .12	.25 / .16	.27 / .20	
Blinds	n/a	n/a	n/a	n/a	.30 / .18	.30 / .18	.34 / .24	.34 / .24	n/a	.39 / .31	.39 / .31	n/a	.26 / .14	.28 / .19	.33 / .23	
Decorative Glass	.22 / .09	.22 / .09	.22 / .09	.22 / .09	.26 / .16	.26 / .16	.29 / .21	.29 / .21	.29 / .21	.32 / .28	.32 / .28	.32 / .28	.23 / .12	.25 / .16	.29 / .20	

Doors with no glass WILL qualify (U-factor = 0.17)

Grand Marais Smooth or Textured Fiberglass Doors	1/4 LITE				1/2 LITE		3/4 LITE			FULL LITE			SIDELITES			
Description -->	Craftsman	1/2 Rnd Top Lite	Center Lite	Twin Top Lite	1/2 Lite	Twin 1/2 Lite	3/4 Lite	Twin 3/4 Lite	3/4 oval	Full Lite	Twin Full Lite	Full Oval	1/2 Lite	3/4 Lite	Full Lite	
Unit qualifies with:																
Clear (IG)	.23 / .12	.23 / .12	.23 / .12	.23 / .12	.28 / .20	.28 / .20	.32 / .26	.32 / .26	.32 / .26	.36 / .34	.36 / .34	.36 / .34	.20 / .07	.22 / .09	.24 / .12	
Low-E	.21 / .10	.21 / .10	.21 / .10	.21 / .10	.24 / .17	.24 / .17	.27 / .22	.27 / .22	.27 / .22	.30 / .28	.30 / .28	.30 / .28	.19 / .06	.20 / .08	.22 / .10	
Blinds	n/a	n/a	n/a	n/a	.28 / .20	.28 / .20	.32 / .26	.32 / .26	n/a	.36 / .34	.36 / .34	n/a	.20 / .04	.22 / .07	.24 / .09	
Decorative Glass	.21 / .10	.21 / .10	.21 / .10	.21 / .10	.25 / .16	.25 / .16	.27 / .21	.27 / .21	.27 / .21	.31 / .27	.31 / .27	.31 / .27	.19 / .06	.20 / .09	.22 / .12	

Doors with no glass WILL qualify (U-factor = 0.16 Flush 0.17 Embossed)

Timbergrain® Fiberglass Doors	1/4 LITE		1/2 LITE		3/4 LITE			SIDELITES		
Description	Craftsman	8-Panel Ctr Arch	1/2 Lite	3/4 Oval 3-Panel	3/4 Oval 2-Panel	3/4 Lite 2-Panel	3/4 Lite 2-Panel Plank	1/2 Lite	3/4 Lite	Full Lite
Unit qualifies with:										
Clear (IG)	.22 / .10	.22 / .10	.27 / .19	.31 / .25	.31 / .25	.31 / .25	.31 / .25	.27 / .11	.30 / .15	.33 / .19
Low-E	.23 / .09	.23 / .09	.26 / .09	.27 / .21	.27 / .21	.27 / .21	.27 / .21	.26 / .09	.27 / .12	.30 / .16
Decorative Glass	.21 / .09	.21 / .09	.24 / .16	.27 / .21	.27 / .21	.27 / .21	.27 / .21	.26 / .10	.27 / .13	.30 / .17

Doors with no glass WILL qualify (U-factor = 0.15 Flush 0.16 Embossed)

UNIT QUALIFIES FOR ENERGY STAR®

Glazing Level	U-Factor ¹	SHGC ²
Opaque	≤ 0.17	No Rating
≤ ½-Lite	≤ 0.25	≤ 0.25
> ½-Lite	≤ 0.30	Northern North-Central ≤ 0.40
		Southern South-Central ≤ 0.25

Air Leakage for Sliding Doors ≤ 0.3 cfm/ft²
Air Leakage for Swinging Doors ≤ 0.5 cfm/ft²

TAYLOR ENTRANCE SYSTEMS - FLORIDA BUILDING CODE APPROVAL SUMMARY



FL#	Product Description					HVHZ	NON HVHZ	IMPACT	Design Pressure			
	Door Type	Configuration	Height	Glazing	Jamb Type				Inswing		Outswing	
									+	-	+	-
8845.1	Steel Edge	X	6'8"	Impact	Wood	Yes	Yes	Yes	50	55	50	55
8845.2	Steel Edge	XO or OX	6'8"	Impact	Wood	Yes	Yes	Yes	50	55	50	55
8845.3	Steel Edge	OXO	6'8"	Impact	Wood	Yes	Yes	Yes	50	55	50	55
8845.4	Steel Edge	XX	6'8"	Impact	Wood	Yes	Yes	Yes	50	55	50	55
8845.5	Steel Edge	OXXO	6'8"	Impact	Wood	Yes	Yes	Yes	50	55	50	55
8845.6	Steel Edge	X	8'0"	Impact	Wood	Yes	Yes	Yes	50	50	50	50
8845.7	Steel Edge	XO or OX	8'0"	Impact	Wood	Yes	Yes	Yes	50	50	50	50
8845.8	Steel Edge	OXO	8'0"	Impact	Wood	Yes	Yes	Yes	50	50	50	50
8845.9	Steel Edge	XX	8'0"	Impact	Wood	Yes	Yes	Yes	50	50	50	50
8845.10	Steel Edge	OXXO	8'0"	Impact	Wood	Yes	Yes	Yes	50	50	50	50
8845.11	Steel Edge	X	6'8"	Opaque	Wood	Yes	Yes	Yes	60	60	60	60
8845.12	Steel Edge	XO or OX	6'8"	Opaque	Wood	Yes	Yes	Yes	60	60	60	60
8845.13	Steel Edge	OXO	6'8"	Opaque	Wood	Yes	Yes	Yes	60	60	60	60
8845.14	Steel Edge	XX	6'8"	Opaque	Wood	Yes	Yes	Yes	60	60	60	60
8845.15	Steel Edge	OXXO	6'8"	Opaque	Wood	Yes	Yes	Yes	60	60	60	60
8845.16	Steel Edge	X	8'0"	Opaque	Wood	Yes	Yes	Yes	50	50	50	50
8845.17	Steel Edge	XO or OX	8'0"	Opaque	Wood	Yes	Yes	Yes	50	50	50	50
8845.18	Steel Edge	OXO	8'0"	Opaque	Wood	Yes	Yes	Yes	50	50	50	50
8846.19	Steel Edge	XX	8'0"	Opaque	Wood	Yes	Yes	Yes	50	50	50	50
8846.20	Steel Edge	OXXO	8'0"	Opaque	Wood	Yes	Yes	Yes	50	50	50	50
9542.1	Steel Edge	X	6'8"	Glazed	Wood	No	Yes	No	40	40	40	40
9542.2	Steel Edge	XO or OX, OXO	6'8"	Glazed	Wood	No	Yes	No	40	40	40	40
9542.3	Steel Edge	XX, OXXO	6'8"	Glazed	Wood	No	Yes	No	40	40	40	40
9542.4	Steel Edge	X	8'0"	Glazed	Wood	No	Yes	No	40	45	40	40
9542.5	Steel Edge	XO or OX, OXO	8'0"	Glazed	Wood	No	Yes	No	40	45	40	40
9542.6	Steel Edge	XX, OXXO	8'0"	Glazed	Wood	No	Yes	No	40	45	40	40
14513.1	Steel Edge	X	7'0"	Opaque	Split Steel	Yes	Yes	Yes	60	60	60	60
14513.2	Steel Edge	X	7'0"	Opaque	Fixed Steel	Yes	Yes	Yes	60	60	60	60
14513.3	Steel Edge	X	7'0"	Opaque	Split Steel	No	Yes	Yes	60	60	60	60
15135.1	Wood Edge	X	6'8"	Glazed	Wood	No	Yes	No	40	40	40	40
15135.2	Wood Edge	XO or OX, OXO	6'8"	Glazed	Wood	No	Yes	No	40	40	40	40
15135.3	Wood Edge	XX, OXXO	6'8"	Glazed	Wood	No	Yes	No	40	40	40	40
15135.4	Wood Edge	X	6'8"	Impact	Wood	No	Yes	Yes	47	47	47	47
15135.5	Wood Edge	XO or OX, OXO	6'8"	Impact	Wood	No	Yes	Yes	47	47	47	47
15135.6	Wood Edge	XX, OXXO	6'8"	Impact	Wood	No	Yes	Yes	47	47	47	47
15135.7	Wood Edge	X	6'8"	Opaque	Wood	No	Yes	Yes	60	60	60	60
15135.10	Wood Edge	XO or OX, OXO	6'8"	Opaque	Wood	No	Yes	Yes	47	47	47	47
15136.11	Wood Edge	XX, OXXO	6'8"	Opaque	Wood	No	Yes	Yes	47	47	47	47
15135.12	Wood Edge	X	8'0"	Opaque	Wood	No	Yes	Yes	60	60	60	60
15135.15	Wood Edge	XO or OX, OXO	8'0"	Opaque	Wood	No	Yes	Yes	50	50	50	50
15135.16	Wood Edge	XX, OXXO	8'0"	Opaque	Wood	No	Yes	Yes	50	50	50	50
15931.1	Timbergrain	X	6'8"	Opaque	Wood	No	Yes	Yes	100	100	100	100
15931.2	Timbergrain	XO, OX or OXO	6'8"	Glazed	Wood	No	Yes	No	55	60	55	55
15932.3	Timbergrain	XX, OXXO	6'8"	Glazed	Wood	No	Yes	No	55	60	55	55
15931.4	Timbergrain	X, OX/XO or OXO	6'8"	Glazed	Wood	No	Yes	No	55	60	55	55
15931.5	Timbergrain	XX or OXXO	6'8"	Glazed	Wood	No	Yes	No	55	60	55	55
15931.60	Timbergrain	X	8'0"	Opaque	Wood	No	Yes	Yes	65	65	70	70
15931.70	Timbergrain	XO, OX or OXO	8'0"	Glazed	Wood	No	Yes	No	55	60	55	55
15932.80	Timbergrain	XX, OXXO	8'0"	Glazed	Wood	No	Yes	No	45	45	45	45
15931.90	Timbergrain	X, OX/XO or OXO	8'0"	Glazed	Wood	No	Yes	No	40	45	40	40
15931.10	Timbergrain	XX or OXXO	8'0"	Glazed	Wood	No	Yes	No	45	45	45	45

FOR DETAILED INSTALLATION INSTRUCTIONS AND EVALUATION REPORTS VISIT WWW.FLORIDABUILDING.ORG



GAF
Safety Data Sheet
SDS # 2093
SDS Date: July 2024

SECTION 1: PRODUCT AND COMPANY INFORMATION

PRODUCT NAME: Timberline HDZ®
 Timberline® UHDZ™
 Timberline® AH
 Timberline® NS
 Timberline® AS II
 Timberline® CS
 Timberline HDZ® RS
 Timberline HDZ® RS+
 Timberline® Solar HDZ™
 Fortitude

TRADE NAME: Asphalt / Fiberglass Shingles

MANUFACTURER: GAF

ADDRESS: 1 Campus Drive, Parsippany, NJ 07054

24-HOUR EMERGENCY PHONE (CHEMTREC): 800 – 424 – 9300

INFORMATION ONLY: 877 – GAF– ROOF

APPROVED BY: Corporate EHS

SECTION 2: HAZARDS IDENTIFICATION

As defined in the OSHA Hazard Communication Standard, 29 CFR 1910.1200, the products listed above are considered articles and do not require an SDS. In addition, articles are not included in the scope of the Globally Harmonization System (GHS). As such, the GHS labeling elements are not included on this SDS. All components listed for this product are bound within the product. When handled as intended and under normal conditions of use, there is no evidence that any of the ingredients are released in amounts that pose a significant health risk. Although these products are not subject to the OSHA Standard or GHS labeling elements, GAF would like to disclose as much health and safety information as possible to ensure that this product is handled and used properly. This SDS contains valuable information critical to the safe handling and proper use of the product. This SDS should be retained and be made available for employees and other users of this product. In addition, the recommendations for handling and use of these products should be included in worker training programs.

ADDITIONAL HAZARD IDENTIFICATION INFORMATION:

PRIMARY ROUTE OF EXPOSURE: Occasional nuisance dust.

SIGNS & SYMPTOMS OF EXPOSURE

Eyes: May cause irritation to the eyes.

Skin: May cause irritation to the skin.

Ingestion:

This product is not intended to be ingested. If ingested, it may cause temporary irritation to the gastrointestinal (digestive) tract

Inhalation:

May cause irritation to the respiratory tract.

ACUTE HEALTH HAZARDS:

NIOSH has found that studies of workers exposed to asphalt fume serous membranes of the conjunctivae (eye irritation) and the mu tract (nasal and throat irritation).

CHRONIC HEALTH HAZARDS:

Studies in humans have found that exposure to respirable crystalline silica (quartz) can cause silicosis, a fibrosis (scarring) of the lungs. Silicosis is a serious and irreversible disease; it may be progressive even after exposure has ceased; it can lead to disability and death. Human studies also have found that silicosis is a risk factor for tuberculosis, and that occupational exposure to respirable crystalline silica is associated with chronic obstructive pulmonary disease, including bronchitis and emphysema.

CARCINOGENICITY:

IARC has determined that occupational exposure to oxidized asphalt and its emissions is probably carcinogenic to humans (Group 2A). IARC concluded that available data from cancer studies in humans points to an association between exposures to oxidized asphalts during roofing and lung cancer and tumors in the upper aero-digestive tract. In addition, IARC found sufficient evidence of carcinogenicity in experimental animals for extracts and fume condensates of oxidized asphalts.

NIOSH has concluded that the collective data from human, animal, genotoxicity and exposure studies provide sufficient evidence that roofing asphalt fumes are a potential occupational carcinogen. Occupational exposure to respirable crystalline silica is classified as a known carcinogen in humans.

IARC has determined that respirable crystalline silica is carcinogenic to humans (Group 1), based on findings of sufficient evidence of carcinogenicity in both humans and experimental animals. NTP has classified respirable crystalline silica as a known human carcinogen based on sufficient evidence of carcinogenicity from studies in humans indicating a causal relationship between exposure to respirable crystalline silica and increased lung cancer rates in workers exposed to crystalline silica dust. NIOSH has determined that respirable crystalline silica is a potential occupational carcinogen.

GAF**SDS # 2093****SECTION 3: COMPOSITION/INFORMATION ON INGREDIENTS**

CHEMICAL NAME	CAS #	%	OCCUPATIONAL EXPOSURE LIMITS		
			OSHA	ACGIH	OTHER
Granules	NA	20-45	NE	NE	NE
Limestone	1317-65-3	25-45	5 mg/m ³ – resp. 15 mg/m ³ – total	3 mg/m ³ – resp. 10 mg/m ³ – total	REL 5 mg/m ³ – resp. 10 mg/m ³ – total
Oxidized Asphalt	64742-93-4	10-30	NE	0.5 mg/m ³ (inhalable fraction as benzene soluble aerosol)	5 mg/m ³ –ceiling
Crystalline Silica	14808-60-7	0-10	50 µg/m ³	0.025 mg/m ³	REL 5 mg/m ³ – ceiling
Fiberglass Mat	65997-17-3	1-3	1 f/cc – resp.	1 f/cc – resp.	REL: 5 mg/m ³ – total fibers
Titanium Dioxide	13463-67-7	0-4	15 mg/m ³ – total	10 mg/m ³ – total	REL: lowest feasible concentration

NE = Not Established**SECTION 4: FIRST AID MEASURES****FIRST AID PROCEDURES**

EYES: Hold eyelids open and wash with gentle stream of water for at least 15 minutes preferably at eyewash fountain.

SKIN: Wash affected area thoroughly with soap and water.

INHALATION: Remove to fresh uncontaminated air.

INGESTION: Not expected to be ingested.

NOTES TO PHYSICIANS OR FIRST AID PROVIDERS: No information available

SECTION 5: FIRE FIGHTING PROCEDURES

SUITABLE EXTINGUISHING MEDIA: Water spray, alcohol foam, carbon dioxide, or dry chemical.

HAZARDOUS COMBUSTION PRODUCTS: Carbon dioxide and carbon monoxide.

RECOMMENDED FIRE FIGHTING PROCEDURES: NIOSH-approved self-contained breathing apparatus is recommended for smoke protection.

UNUSUAL FIRE & EXPLOSION HAZARDS: None.

SECTION 6: ACCIDENTAL RELEASE MEASURES

ACCIDENTAL RELEASE MEASURES: Pick up or sweep up pieces. Avoid creating dust during clean up.

SECTION 7: HANDLING AND STORAGE

HANDLING AND STORAGE: No specific handling or storage requirements.

OTHER PRECAUTIONS: None

SECTION 8: EXPOSURE CONTROLS/PERSONAL PROTECTION

ENGINEERING CONTROLS / VENTILATION: None.

RESPIRATORY PROTECTION: Not applicable under normal use conditions. In circumstances where dust or fumes are generated and may exceed recognized allowable exposure levels, appropriate NIOSH approved respiratory protection is recommended.

EYE PROTECTION: Safety glasses with side shields

SKIN PROTECTION: Cotton or leather gloves are recommended when handling.

OTHER PROTECTIVE EQUIPMENT: None

WORK HYGIENIC PRACTICES: Wash exposed skin prior to eating, drinking or smoking and at the end of each shift.

SECTION 9: PHYSICAL AND CHEMICAL PROPERTIES

APPEARANCE & ODOR:	Granule coated shingle; no appreciable odor. Various colors.		
FLASH POINT:	> 550 °F	LOWER EXPLOSIVE LIMIT:	Not Applicable
METHOD USED:	Not Applicable	UPPER EXPLOSIVE LIMIT:	Not Applicable
EVAPORATION RATE:	Not Applicable	BOILING POINT:	Not Applicable
pH (undiluted product):	Not Applicable	MELTING POINT:	Not Applicable
SOLUBILITY IN WATER:	Not Applicable	SPECIFIC GRAVITY:	Not Applicable
VAPOR DENSITY:	Not Applicable	PERCENT VOLATILE:	Not Applicable
VAPOR PRESSURE:	Not Applicable	MOLECULAR WEIGHT:	Not Applicable
VOC WITH WATER (LBS/GAL):	Not Applicable	WITHOUT WATER (LBS/GAL):	Not Applicable

SECTION 10: STABILITY AND REACTIVITY

THERMAL STABILITY: **STABLE** **UNSTABLE**

CONDITIONS TO AVOID (STABILITY): None known.

INCOMPATIBILITY (MATERIAL TO AVOID): None known.

HAZARDOUS DECOMPOSITION OR BY-PRODUCTS: Carbon dioxide and carbon monoxide

HAZARDOUS POLYMERIZATION: Will not occur.

SECTION 11: TOXICOLOGICAL INFORMATION

TOXICOLOGICAL INFORMATION:

Eyes: May cause irritation to the eyes.

Skin: May cause irritation to the skin.

Ingestion: Ingestion may cause discomfort and/or distress.

Inhalation: May cause irritation to the respiratory tract.

SECTION 12: ECOLOGICAL INFORMATION

ECOLOGICAL INFORMATION: No information available.

SECTION 13: DISPOSAL CONSIDERATIONS

WASTE DISPOSAL METHOD: Comply with Federal, State and local regulations for disposal.

SECTION 14: TRANSPORTATION INFORMATION

DOT
Not regulated as dangerous goods.

IATA
Not regulated as dangerous goods.

IMDG
Not regulated as dangerous goods,

SECTION 15: REGULATORY INFORMATION

U.S. FEDERAL REGULATIONS

TSCA: This product and its components are listed on the TSCA 8(b) inventory.

CERCLA: None

SARA None

311 / 312 HAZARD CATEGORIES: None

313 REPORTABLE INGREDIENTS: None

CALIFORNIA PROPOSITION 65: This product contains silica, oxidized asphalt and titanium dioxide, chemicals known to the State of California to cause cancer

Other state regulations may apply. Check individual state requirements. The following components appear on one or more of the following state hazardous substances lists:

GAF**SDS # 2093**

Chemical Name	CAS #	CA	MA	MN	NJ	PA	RI
Limestone	1317-65-3	No	Yes	Yes	No	Yes	Yes
Crystalline Silica	14808-60-7	Yes	Yes	Yes	Yes	Yes	Yes
Oxidized Asphalt	64742-93-4	No	No	No	No	No	No

SECTION 16: OTHER INFORMATION

ADDITIONAL COMMENTS: None.

DATE OF PREVIOUS SDS: July 2021

CHANGES SINCE PREVIOUS SDS: Updated product names.

This information relates to the specific material designated and may not be valid for such material used in combination with any other materials or in any process. Such information is to the best of our knowledge and belief accurate and reliable as of the date compiled. However, no representation, warranty or guarantee, expressed or implied, is made as to its accuracy, reliability, or completeness. It is the user's responsibility to satisfy himself as to the suitability and completeness of such information for his particular use. We do not accept liability for any loss or damage that may occur from the use of this information. Nothing herein shall be construed as a recommendation for uses which infringe valid patents or as extending a license of valid patents.



America's #1-selling shingle just got better — again

Now featuring a 25-Year Limited Warranty against
blue-green algae discoloration*



Now with GAF Time-Release Algae-Fighting
Technology and LayerLock™ Technology,
Timberline HDZ® offers everything
you can expect from an architectural
shingle roof, and more.*

* See reverse for details



We protect what matters most™



Timberline HDZ[®] Shingles

Benefits:

- **LayerLock™ Technology** mechanically fuses the common bond between overlapping shingle layers.
- The added strength at the common bond powers the **StrikeZone™** — The industry's widest nailing area.
- **Up to 99.9% nailing accuracy** — The StrikeZone™ nailing area is so easy to hit that a roofer placed 999 out of 1,000 nails correctly in our test.³
- **Up to 30% faster nail fastening** thanks to the industry's largest nail zone.³
- **Dura Grip™** sealant pairs with the smooth microgranule surface of the StrikeZone™ nailing area for fast tack. Then, an asphalt-to asphalt monolithic bond cures for durability, strength, and exceptional wind uplift performance.
- **WindProven™ Limited Wind Warranty²** — When installed with the required combination of GAF Accessories, Timberline HDZ[®] Shingles are eligible for an industry first: a wind warranty with no maximum wind speed limitation.
- **25-year StainGuard Plus™ Algae Protection Limited Warranty** against blue-green algae discoloration.¹ Proprietary GAF Time-Release Algae-Fighting Technology helps protect shingles from unsightly stains.

Installation:



The StrikeZone™ Nailing Area

The industry's largest nailing area for up to 99.9% nail placement accuracy.²



LayerLock™ Technology

Proprietary technology mechanically fuses the common bond between overlapping shingle layers.

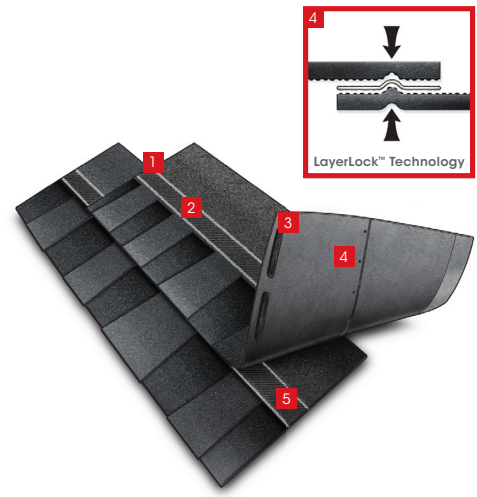

1. Alignment guide
2. StrikeZone™ Nailing Area
3. Dura Grip™ Adhesive
4. LayerLock™ Technology
5. Smooth microgranule surface



Visit gaf.com/TimberlineHDZ

¹ 25-year StainGuard Plus™ Algae Protection Limited Warranty against blue-green algae discoloration is available only on products sold in packages bearing the StainGuard Plus™ logo. See *GAF Shingle & Accessory Limited Warranty* for complete coverage and restrictions.

² 15-year WindProven™ limited wind warranty on Timberline HDZ[®] Shingles requires the use of GAF starter strips, roof deck protection, ridge cap shingles, and leak barrier or attic ventilation. See *GAF Roofing System Limited Warranty* for complete coverage and restrictions. Visit gaf.com/LRS for qualifying GAF products.

³ Results based on study conducted by Home Innovation Research Labs, an independent research lab, comparing installation of Timberline HD[®] Shingles to Timberline HDZ[®] Shingles on a 16-square roof deck using standard 4-nail nailing pattern under controlled laboratory conditions. Actual results may vary.

We protect what matters most™



Dura Grip™ Adhesive



Don't let the wind win



Wind. We can't control it, but we can resist it. Dura Grip™ Adhesive helps protect your roof investment from winds and wind-driven rain. And that's not all. When combined with LayerLock™ Technology and the required combination of four qualifying GAF Accessories, it helps provide the holding power behind the WindProven™ Limited Wind Warranty — the industry's first wind warranty with infinite wind speed protection.

Dura Grip™ Adhesive

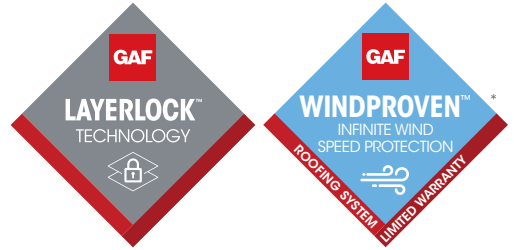

Protection against wind and rain

Under every GAF Shingle you'll find a long black strip of tacky adhesive, running the length of the shingle, just a few inches from the edge.

That's our proprietary Dura Grip™ Adhesive.

Once your roofer nails the shingle in place the sun's heat activates the Dura Grip™ Adhesive, creating a strong bond between the shingle and the layer below it. The activated adhesive also acts as a sealant that helps prevent water penetration at the leading edge of each row of shingles.

Tested

The strong Dura Grip™ Adhesive bond helps GAF Shingles pass the industry's two toughest wind resistance tests: ASTM D3161, Class F, 110 mph, and ASTM D7158, Class H, 150 mph (testing performed under controlled laboratory conditions).

Dura Grip™ Adhesive plus LayerLock™ Technology power the WindProven™ Limited Wind Warranty

Dura Grip™ Adhesive helps create a strong protective bond on all GAF Shingles. But that's not all. When it's combined with our patented LayerLock™ Technology, it pairs with the smooth microgranule surface of the StrikeZone™ nailing area for a fast tack. The two innovative technologies work together to create a bond so strong that GAF was able to introduce the industry's first wind warranty with no maximum wind speed limitation.

When installed with the required combination of four qualifying GAF accessories, Timberline® Shingles with LayerLock™ Technology qualify for the WindProven™ Limited Wind Warranty.*

* 15-year WindProven™ limited wind warranty on Timberline® Shingles with LayerLock™ Technology requires the use of GAF starter strips, roof deck protection, ridge cap shingles, and leak barrier or attic ventilation. See GAF Roofing System Limited Warranty for complete coverage and restrictions. Visit gaf.com/LRS for qualifying GAF products.

GAF Shingle featuring LayerLock™ Technology

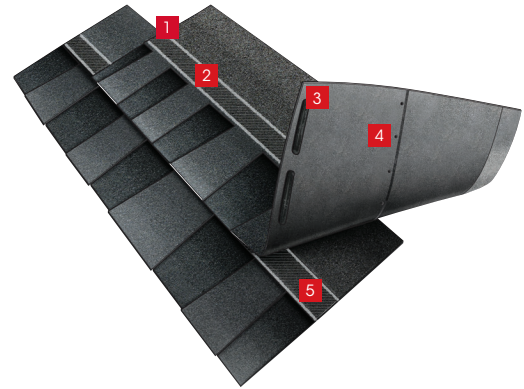

1. Alignment guide
2. StrikeZone™ Nailing Area
3. Dura Grip™ Adhesive
4. LayerLock™ Technology
5. Smooth microgranule surface



Visit gaf.com/windproven

We protect what matters most™





Timberline[®]
America's #1-Selling Shingles



Millions of families have found shelter and peace of mind under a Timberline[®] roof.



We protect what matters most[™]

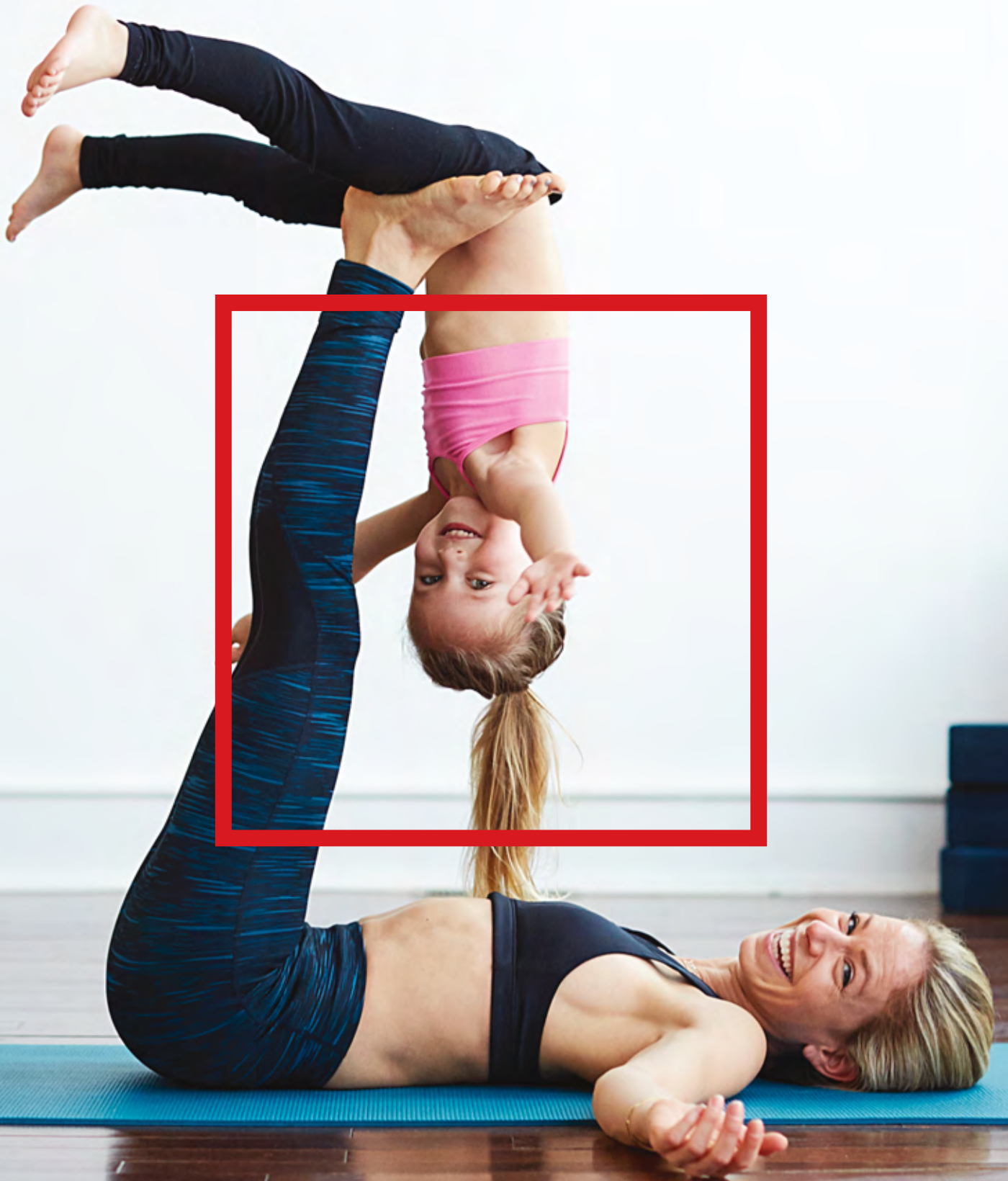

It's never just a roof. It's a promise, kept.

Providing a home means making a promise — of shelter, security, and stability. It says to the people who count on you, “You’re going to be safe, dry, and warm under this roof.”

Choosing a genuine Timberline® roof is a great way to help keep that promise.

It's a system, built to protect

A roof is so much more than shingles. It's layers of protection, working together to keep your home safe from wind, rain, snow, and even sun.

Peek under the shingles at gaf.com/System

Install any GAF Lifetime[†] Shingle and any 3 qualifying GAF Accessories and get a Lifetime[†] limited warranty on your qualifying GAF products plus

non-prorated coverage for the first 10 years. For even stronger coverage, ask your GAF factory-certified contractor[‡] about enhanced GAF warranties.



[†] Lifetime refers to the length of warranty coverage provided and means as long as the original individual owner(s) of a single-family detached residence [or eligible second owner(s)] owns the property where the qualifying GAF products are installed. For other owners/structures, Lifetime coverage is not applicable. Lifetime coverage on shingles requires the use of GAF Lifetime Shingles only. See the *GAF Shingle & Accessory Limited Warranty* for complete coverage and restrictions. Visit gaf.com/LRS for qualifying GAF products. Lifetime coverage on shingles and accessories requires the use of any GAF Lifetime Shingle and at least 3 qualifying GAF Accessories. See the *GAF Roofing System Limited Warranty* for complete coverage and restrictions. For installations not eligible for the *GAF Roofing System Limited Warranty*, see the *GAF Shingle & Accessory Limited Warranty*. Visit gaf.com/LRS for qualifying GAF products.

[‡] Contractors enrolled in GAF certification programs are not employees or agents of GAF, and GAF does not control or otherwise supervise these independent businesses. Contractors may receive benefits, such as loyalty rewards points and discounts on marketing tools from GAF for participating in the program and offering GAF enhanced warranties, which require the use of a minimum amount of GAF products.

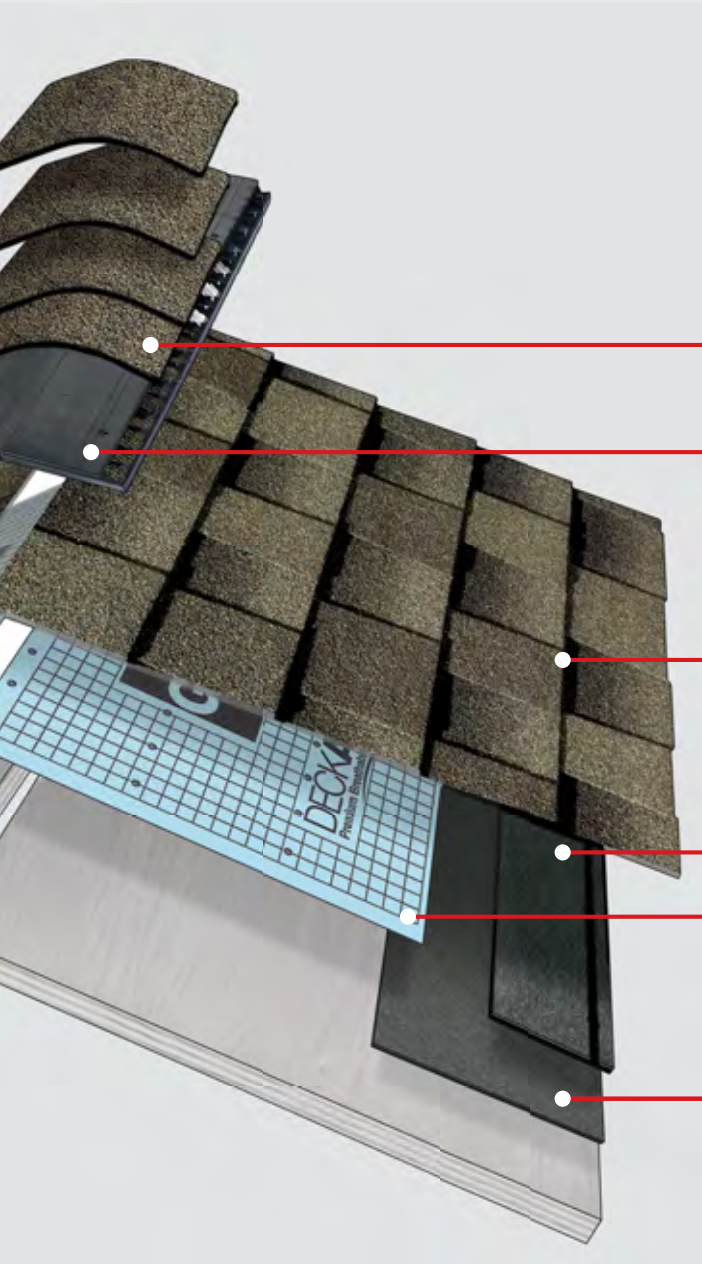

Ridge Cap Shingles



Cobra® Attic Ventilation



Lifetime⁺ Shingles



Starter Strip Shingles



Roof Deck Protection



Leak Barrier



Color shown: Charcoal



Timberline HDZ® Shingles

America's #1-selling shingle got even better. Timberline HDZ® Shingles feature LayerLock® Technology, which powers the industry's widest nail zone. When installed with the required combination of four qualifying GAF Accessories, Timberline HDZ® Shingles are eligible for an industry first: a wind warranty with no maximum wind speed limitation.¹ And now, with a 25-year StainGuard Plus™ Algae Protection Limited Warranty,² Timberline HDZ® offers everything you can expect from an architectural shingle roof, and more. gaf.com/TimberlineHDZ



Barkwood



Charcoal

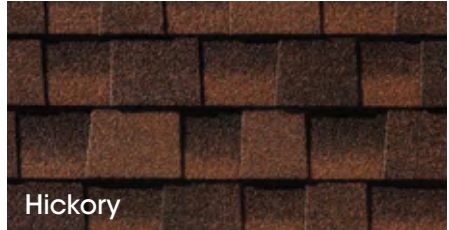

Hickory



Hunter Green

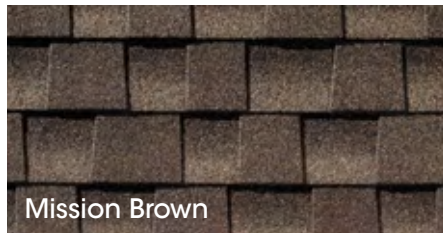

Mission Brown

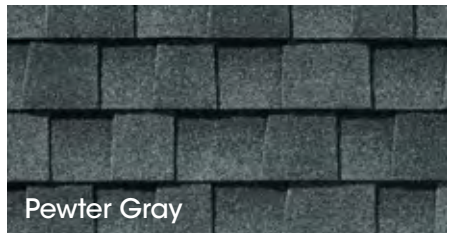

Pewter Gray

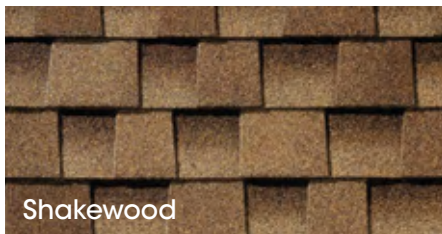

Shakedown



Slate

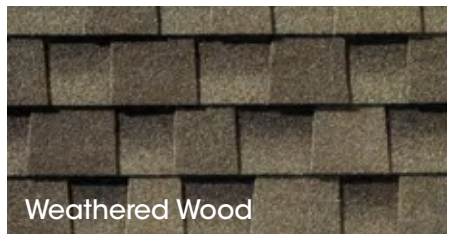

Weathered Wood

Harvest Blend Colors

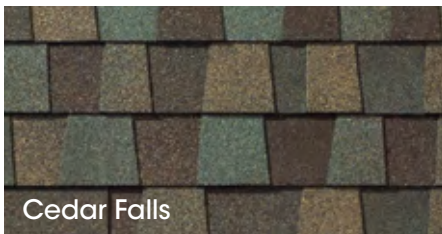

Cedar Falls

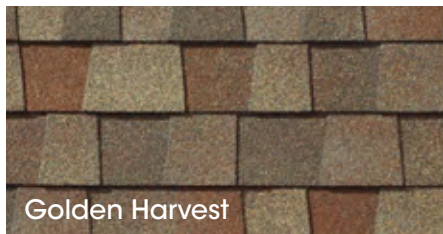

Golden Harvest

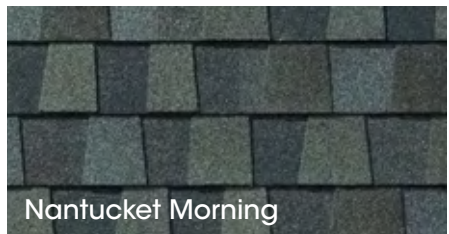

Nantucket Morning

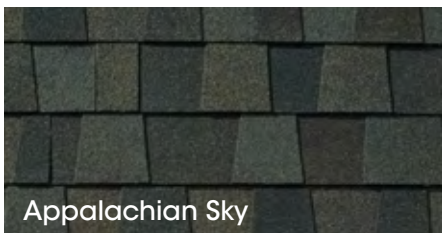

Appalachian Sky

¹ 15-year WindProven™ limited wind warranty on Timberline HDZ® Shingles requires the use of GAF Starter Strips, Roof Deck Protection, Ridge Cap Shingles, and Leak Barrier or Attic Ventilation. See *GAF Roofing System Limited Warranty* for complete coverage and restrictions. Visit gaf.com/LRS for qualifying GAF products. For installations not eligible for the WindProven™ limited wind warranty, see *GAF Shingle & Accessory Limited Warranty* for complete coverage and restrictions.

² 25-year StainGuard Plus™ Algae Protection Limited Warranty against blue-green algae discoloration is available only on products sold in packages bearing the StainGuard Plus™ logo. See *GAF Shingle & Accessory Limited Warranty* for complete coverage and restrictions.

Note: It is difficult to reproduce the color clarity and actual color blends of these products. Before selecting your color, please ask to see several full-size shingles.

Color shown: Pewter Gray



Timberline® UHDZ™ Shingles

Beyond beauty. Beyond your expectations. For homeowners ready to go beyond, Timberline® UHDZ™ — Ultra High Definition — shingles offer a combination of beauty and benefits that go beyond any shingle GAF has offered to date. They feature Dual Shadow Line for dramatic sunset shadows all day long and a 30-year StainGuard Plus PRO™ limited warranty² against blue-green algae discoloration. gaf.com/UHDZ

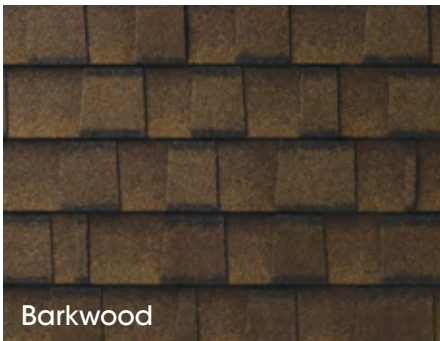

Barkwood



Weathered Wood

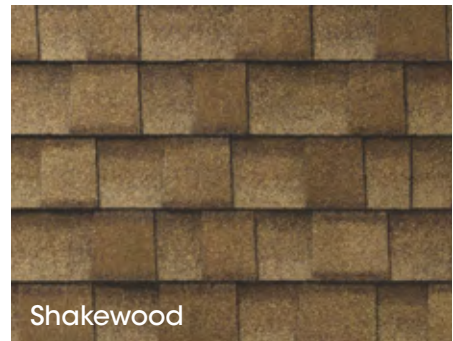

Shakewood



Slate

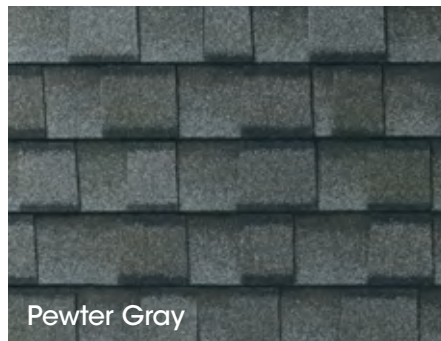

Pewter Gray



Charcoal

¹ Warranty for complete coverage and restrictions. Visit gaf.com/LRS for qualifying GAF products. For installations not eligible for the WindProven™ limited wind warranty, see *GAF Shingle & Accessory Limited Warranty* for complete coverage and restrictions.

² 30-year StainGuard Plus PRO™ Algae Protection Limited Warranty against blue-green algae discoloration is available only on products sold in packages bearing the StainGuard Plus PRO™ logo. See *GAF Shingle & Accessory Limited Warranty* for complete coverage and restrictions, and qualifying products.

Note: It is difficult to reproduce the color clarity and actual color blends of these products. Before selecting your color, please ask to see several full-size shingles.

Timberline® NS Shingles

Select from subtle, even tones and a natural wood-shake look in an asphalt shingle. gaf.com/NS



Weathered Wood

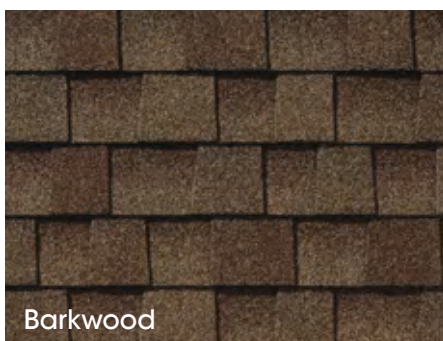

Barkwood



Shakewood

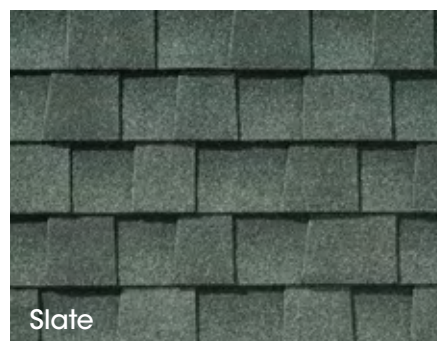

Slate

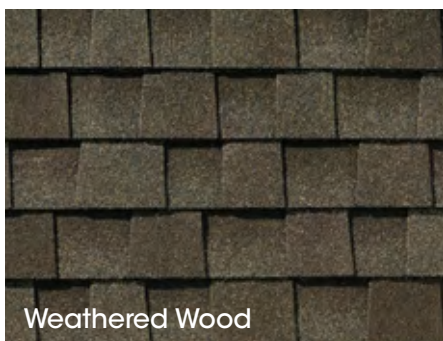

Weathered Wood



Charcoal

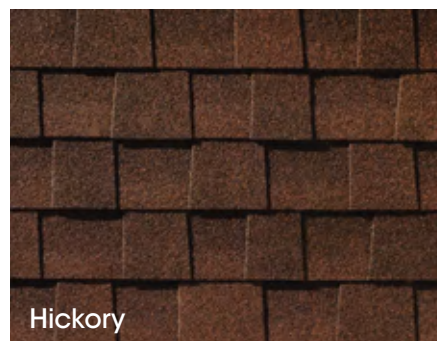

Hickory



Pewter Gray

¹ 10-year StainGuard® Algae Protection Limited Warranty against blue-green algae discoloration is available only on products sold in packages bearing the StainGuard® logo. See *GAF Shingle & Accessory Limited Warranty* for complete coverage and restrictions, and qualifying products.

Note: It is difficult to reproduce the color clarity and actual color blends of these products. Before selecting your color, please ask to see several full-size shingles.

Timberline® AS II Shingles

Protect your most valuable asset. Timberline® ArmorShield™ II SBS Modified IR Shingles combine all the beauty of Timberline® Shingles with UL 2218 Class 4 impact resistance — and may qualify for insurance discounts.¹

gaf.com/ASII



¹ Insurance discounts may not be available in your area. Where available, insurance discounts may vary. Contact your insurance provider for information.

² 15-year WindProven™ limited wind warranty on GAF Shingles with LayerLock® Technology requires the use of GAF Starter Strips, Roof Deck Protection, Ridge Cap Shingles, and Leak Barrier or Attic Ventilation. See *GAF Roofing System Limited Warranty* for complete coverage and restrictions. Visit gaf.com/LRS for qualifying GAF products. For installations not eligible for the *GAF Roofing System Limited Warranty*, see the *GAF Shingle & Accessory Limited Warranty*.

³ 25-year StainGuard Plus™ Algae Protection Limited Warranty against blue-green algae discoloration is available only on products sold in packages bearing the StainGuard Plus™ logo. See *GAF Shingle & Accessory Limited Warranty* for complete coverage and restrictions, and qualifying products.

Note: It is difficult to reproduce the color clarity and actual color blends of these products. Before selecting your color, please ask to see several full-size shingles.



It's the first name in architectural shingles

Literally. When GAF introduced Timberline® Shingles more than 50 years ago, we created a whole new category of roofing. Known as “laminated” or “architectural” shingles, Timberline® set a new standard for innovation and style. Today, a Timberline® roof protects 1 in 4 U.S. families and it's the #1-selling shingle brand in North America.

Find the Timberline® Shingle color that suits your home and lifestyle at [gaf.com/VHR](https://www.gaf.com/VHR)



It's engineered to endure

A GAF roof is built tough. Proprietary GAF Dura Grip™ Adhesive seals each shingle tightly and reduces the risk of shingle blow-off. In fact, GAF Timberline® Shingles are warranted to withstand winds up to 130 mph.¹

And now, any Timberline® Shingles that feature LayerLock® Technology may qualify for the WindProven™ Limited Wind Warranty — the industry's first wind warranty with no maximum wind speed limitation when installed with the required combination of four qualifying GAF accessories.²

Timberline® Shingles have earned the highest roofing fire rating — UL Class A, Listed to ANSI/UL 790.

See how GAF LayerLock® Technology mechanically fuses and strengthens the common bond between shingle layers.

gaf.com/LayerLock



¹15 year 130 mph wind speed coverage requires special installation and use of GAF Starter Strip Shingles; see *GAF Shingle & Accessory Limited Warranty* for details.

²15-year WindProven™ limited wind warranty on Timberline® Shingles with LayerLock® Technology requires the use of GAF Starter Strips, Roof Deck Protection, Ridge Cap Shingles, and Leak Barrier or Attic Ventilation. See *GAF Roofing System Limited Warranty* for complete coverage and restrictions. Visit gaf.com/LRS for qualifying GAF products. For installations not eligible for the WindProven™ limited wind warranty, see *GAF Shingle & Accessory Limited Warranty* for complete coverage and restrictions.

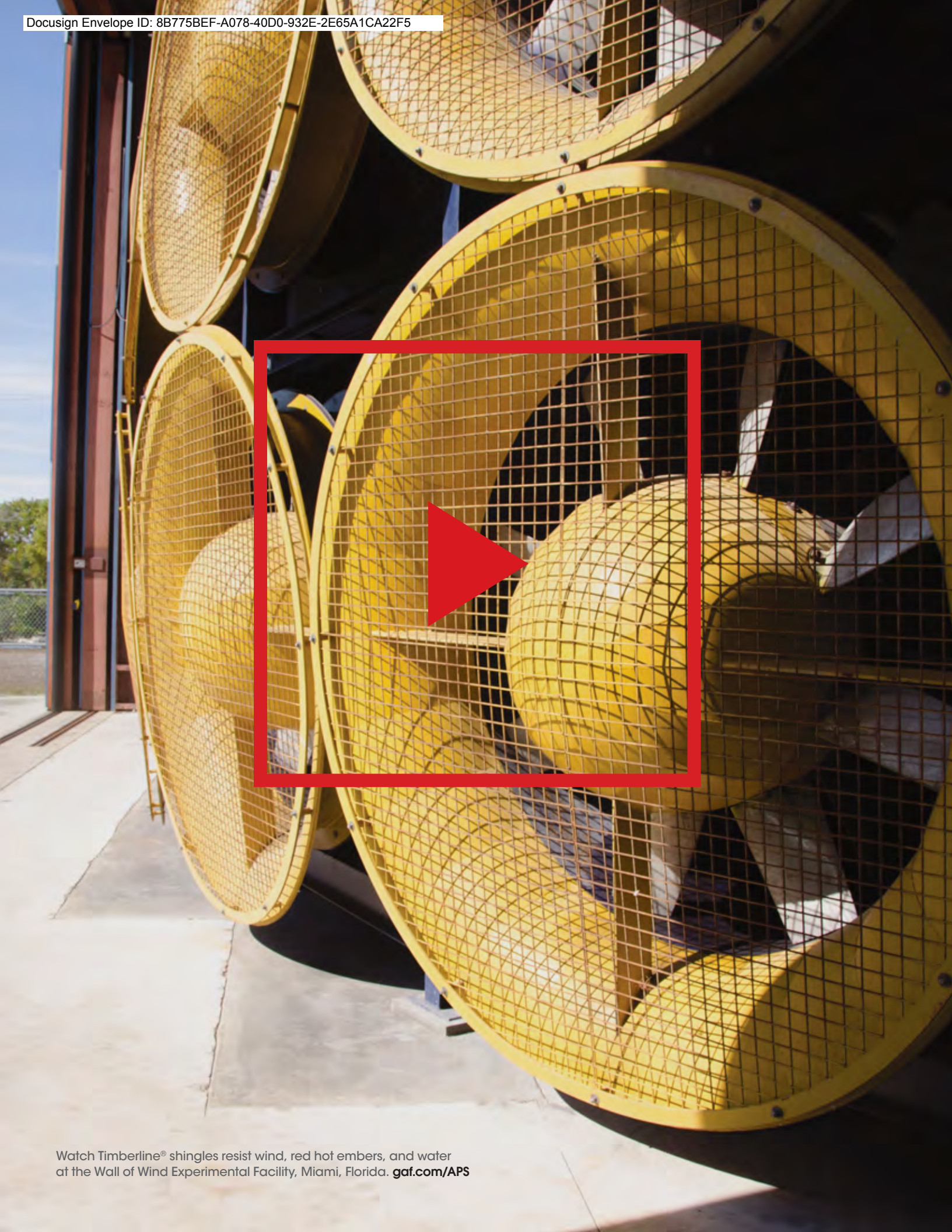

Watch Timberline® shingles resist wind, red hot embers, and water at the Wall of Wind Experimental Facility, Miami, Florida. [gaf.com/APS](https://www.gaf.com/APS)

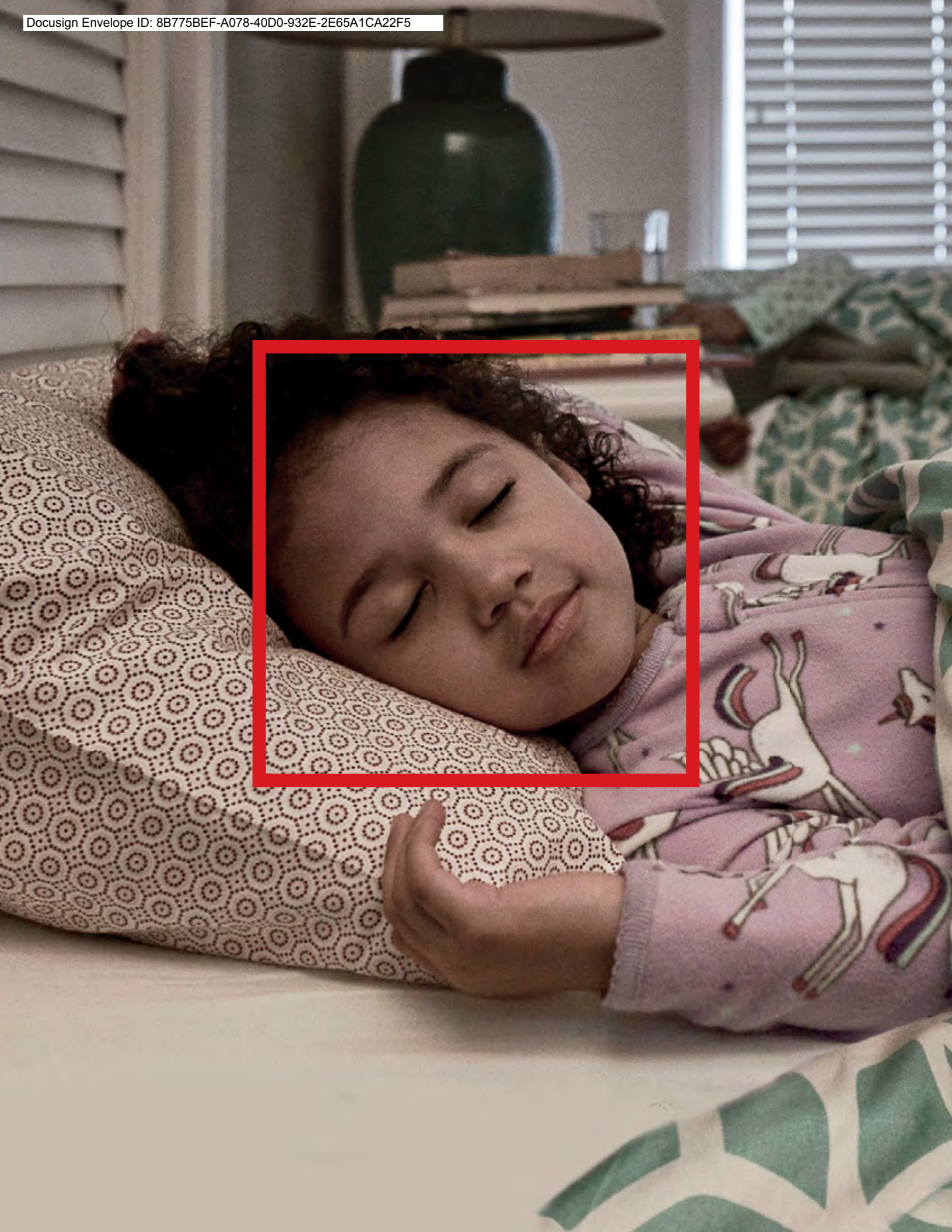

It's a good night's sleep

We can't do anything about barking dogs or car alarms, but we can help you rest a little easier knowing your new Timberline® roof comes with a warranty backed by GAF, North America's largest roofing manufacturer.

Compare warranty choices at gaf.com/Warranty

Every GAF Timberline® Shingle comes with a GAF transferable Lifetime[†] limited warranty, plus the backing of the Good Housekeeping Seal.



[†] Lifetime refers to the length of warranty coverage provided and means as long as the original individual owner(s) of a single-family detached residence [or eligible second owner(s)] owns the property where the qualifying GAF products are installed. For other owners/structures, Lifetime coverage is not applicable. Lifetime coverage on shingles requires the use of GAF Lifetime Shingles only. See the *GAF Shingle & Accessory Limited Warranty* for complete coverage and restrictions. Visit gaf.com/LRS for qualifying GAF products. Lifetime coverage on shingles and accessories requires the use of any GAF Lifetime Shingle and at least 3 qualifying GAF Accessories. See the *GAF Roofing System Limited Warranty* for complete coverage and restrictions. For installations not eligible for the *GAF Roofing System Limited Warranty*, see the *GAF Shingle & Accessory Limited Warranty*. Visit gaf.com/LRS for qualifying GAF products.

It's making a difference

GAF Advanced Protection® Shingle Technology reduces unnecessary waste of natural resources by using ideal amounts of asphalt and limestone. Advanced Protection® Shingles are also weight-optimized to minimize fuel use, and result in less landfill waste when the shingles are eventually replaced. And finally, GAF supports shingle recycling programs that turn old roofs into new roads.

Learn more about the GAF sustainability commitment at gaf.com/About





Color shown: Pewter Gray

