



JELD-WEN
WINDOWS & DOORS

W-2500™

Aluminum Clad-
Wood Windows
Geometric Direct Set

Architectural Design Manual



TABLE OF CONTENTS

Product Information

General Information.....	2
Standard Window Shapes.....	3
Grid Patterns	4
Grid Options	5
Unit Sizing	6
Trim & Sill Nose Options	7
Jamb Extender Options.....	8

Section Details

Stationary Straightline	9
Stationary Radius-Top.....	10

Sizing Details

Min-Max Standard Sizing	11
-------------------------------	----

GENERAL INFORMATION

Standard Sizes & Designs

W-2500™ Clad-Wood Geometric Direct Set windows are produced exclusively to customer order and are available in a nearly infinite range of sizes and shapes. Specified sizes, angles, and radii can be attained in finished units to meet the most demanding architectural requirements.

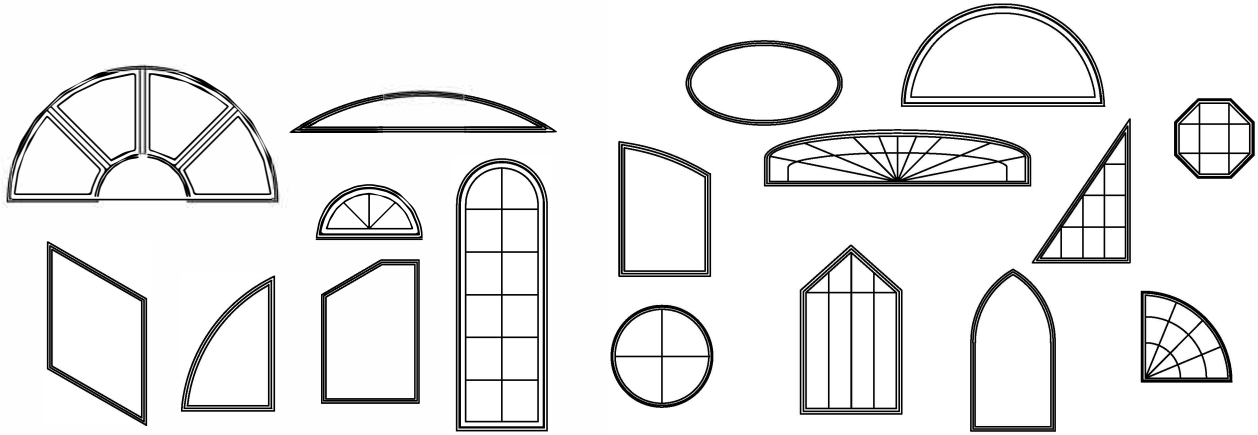

Multiple Assemblies

W-2500™ Clad-Wood Geometric Direct Set windows may be mullioned beside other clad-wood geometric windows, or to other clad-wood window products, to fulfill a variety of architectural design needs.

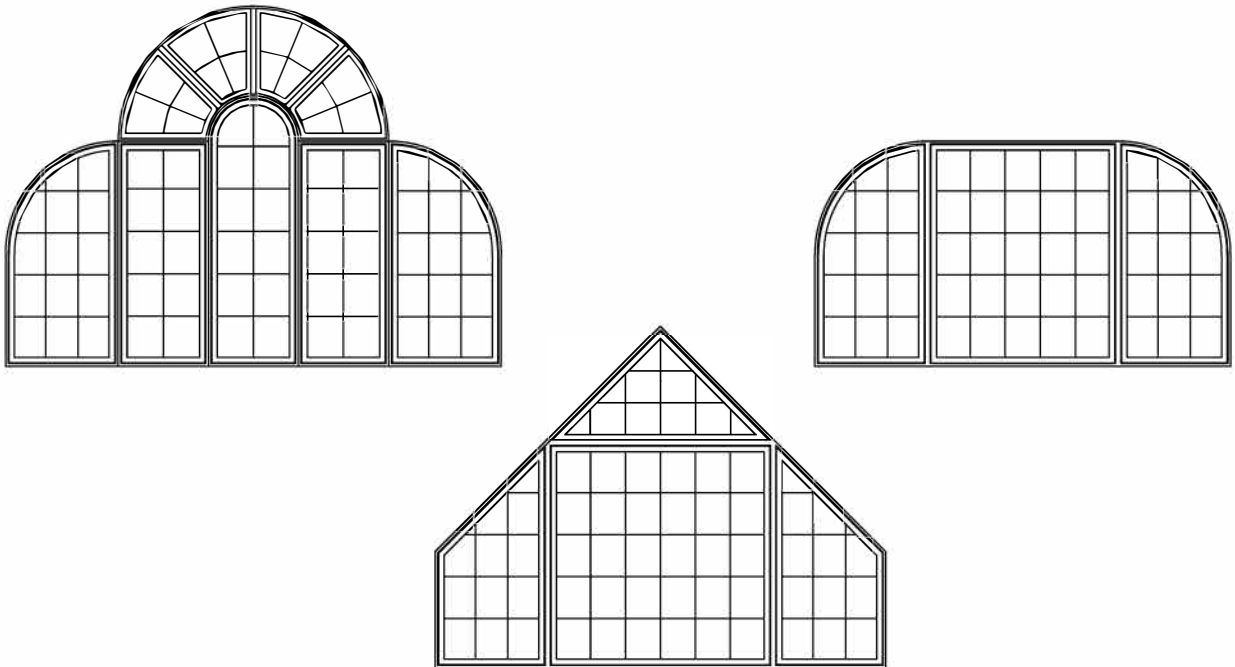



STANDARD WINDOW SHAPES



Rectangular

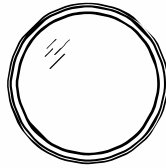

Full Round



Half Round



Extended
Half Round

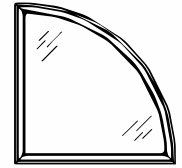

Quarter Round



Extended
Quarter Round



Circle Segment



Extended
Circle Segment

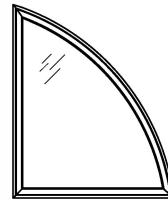

Quarter Segment

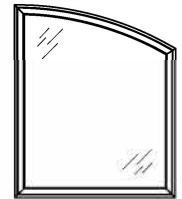

Extended
Quarter Segment



Ellipse

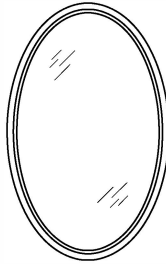

Oval



Gothic

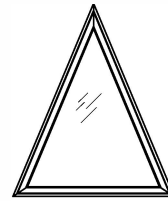

Triangle

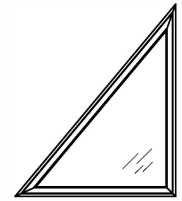

Right Triangle



Trapezoid

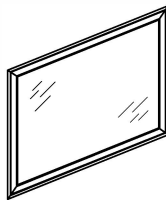

Parallelogram



Pentagon

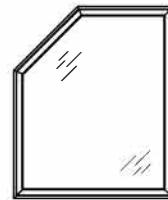

Clipped Corner



Octagon



GRID PATTERNS

W-2500™ Clad-Wood Geometric Direct Set Windows are available with removable grilles, Grilles Between Glass (GBG), or Simulated Divided Lites (SDL) in various styles and widths. The standard grid patterns for rectangular units are shown below. Standard grid patterns vary with window style.

Special grid patterns can include a wide variety of straight line and radius patterns. Non-standard patterns are subject to factory approval.

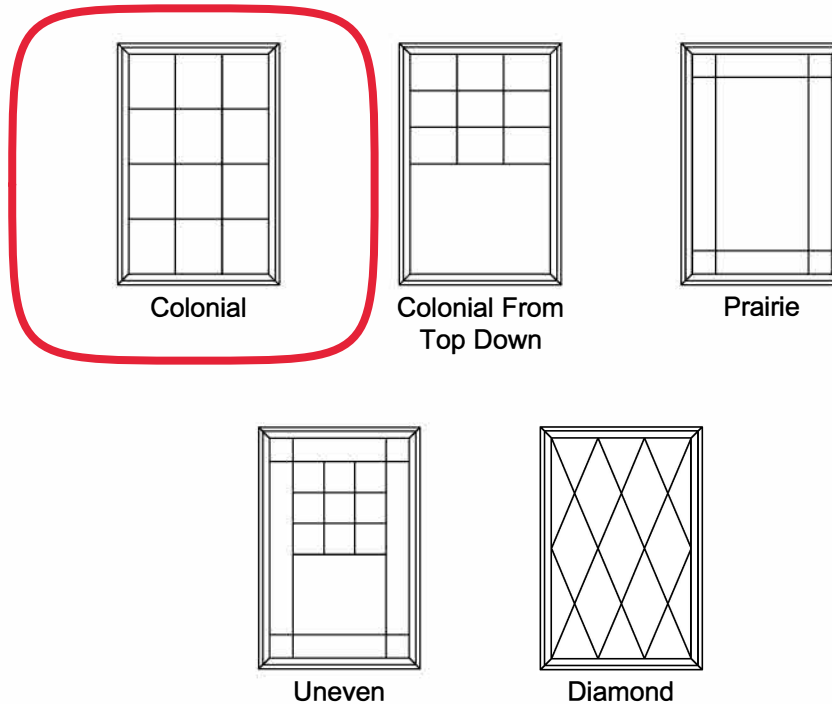

Bar Alignment

Alignment of bars from product to product is often required. SDL, GBG, and wood grilles may be specified with bars aligned.

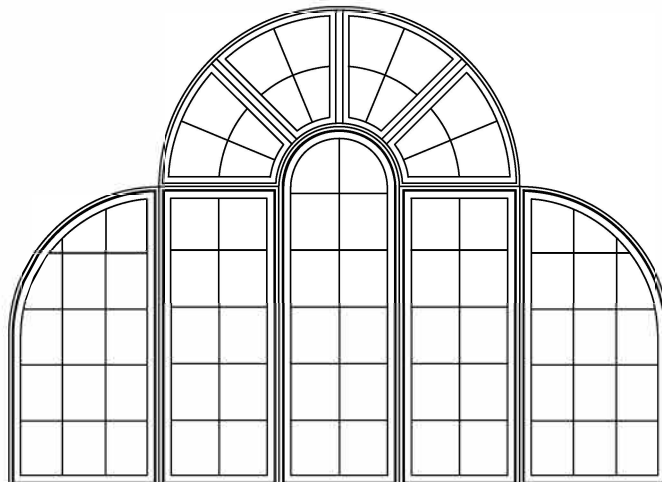



GRID OPTIONS

Exterior ← → Interior

SDL Options

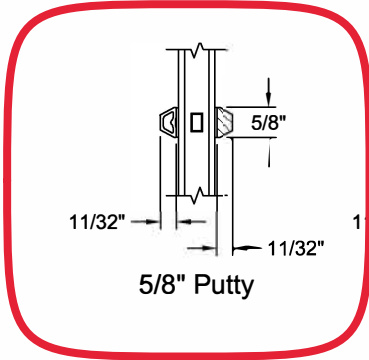

5/8" Putty

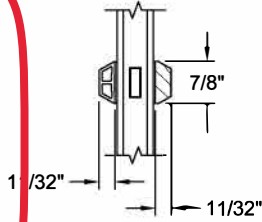

7/8" Putty

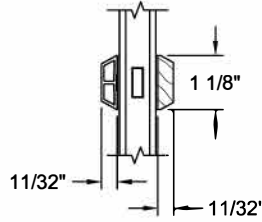

1 1/8" Putty

Various combinations of the SDL bars shown are available.

SDLs are permanent. Interior Grille and Surround are removable.

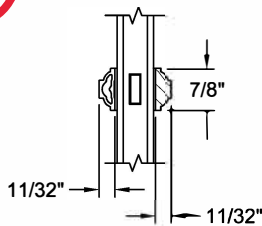

7/8" Bead

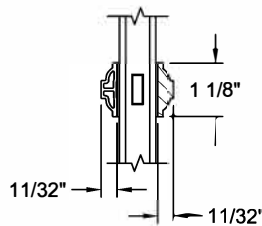

1 1/8" Bead

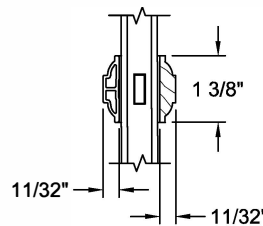

1 3/8" Bead

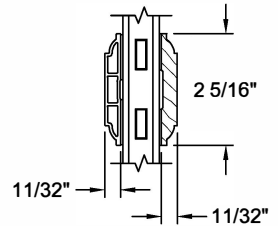

2 5/16" Bead

GBG Options



5/8" Flat

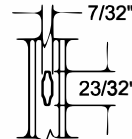

23/32" Contoured



1" Contoured

Grille Options

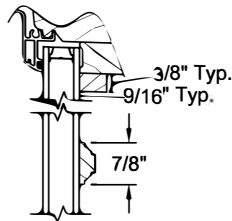

7/8" Full Surround

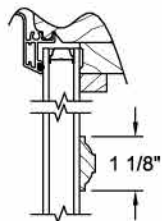

1 1/8" Full Surround

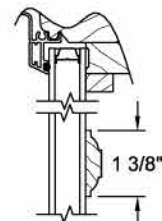

1 3/8" Full Surround

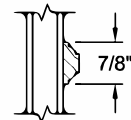

7/8" Wood Grille

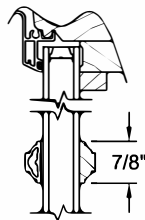

7/8" Bead SDL w/Full Surround

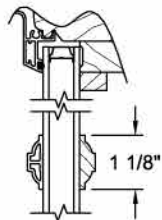

1 1/8" Bead SDL w/Full Surround

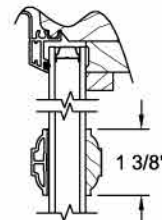

1 3/8" Bead SDL w/Full Surround



UNIT SIZING

Rough Opening

The frame size of the window plus 3/4".

Masonry Opening

The overall size of the window, including trim, plus 1/2".

Trim - 4 Sides of Unit

When applied to 4 sides of unit, these dimensions apply to both vertical and horizontal window sections.

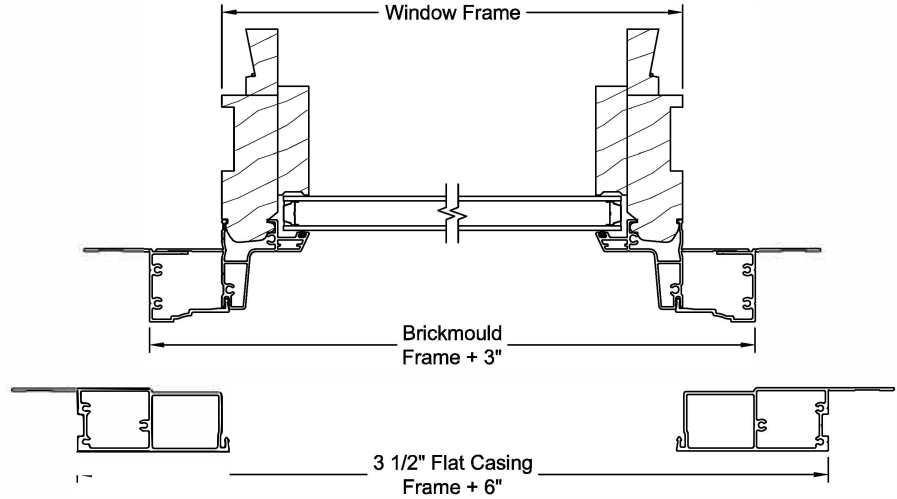

Trim - 3 Sides of Unit

When applied to 3 sides of unit, with 1" Sill Nose, these dimensions apply to vertical sections only.

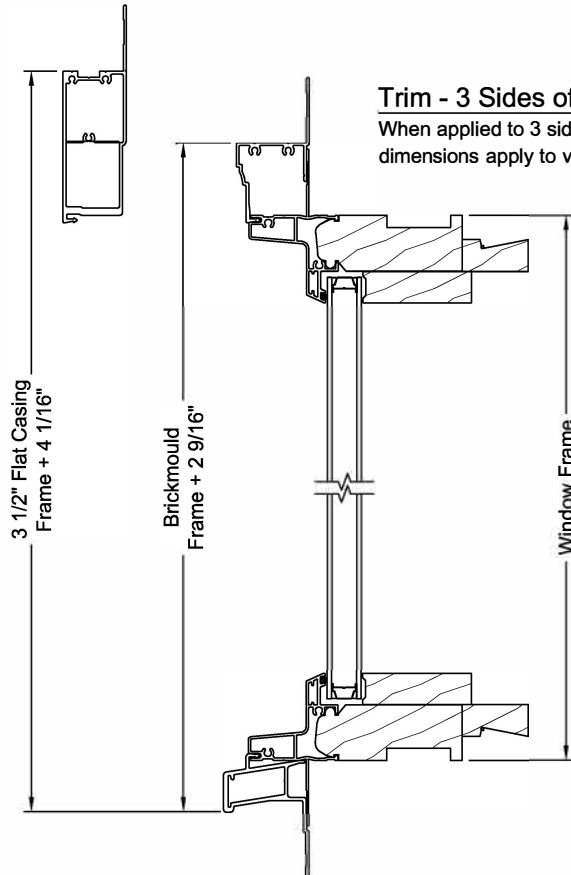



TRIM & SILL NOSE OPTIONS

Trim Options

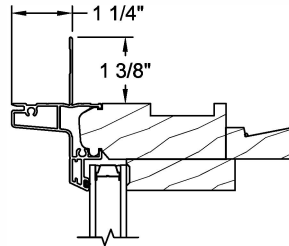

Standard Nail Fin

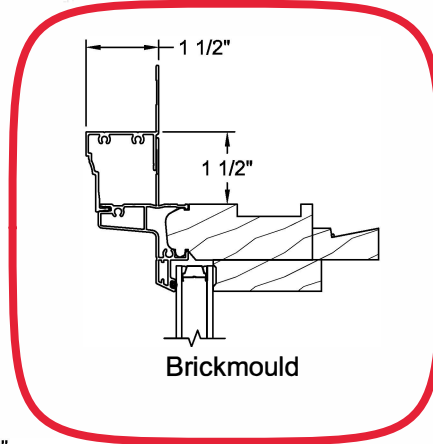

Brickmould

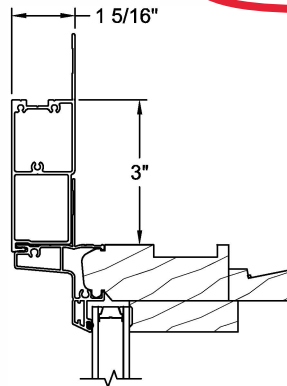

3 1/2" Flat Casing

Trim shown without drip cap for clarity.

Sill Nose Options

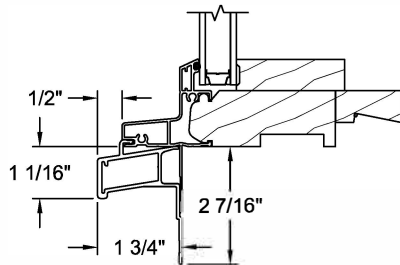

1" Sill Nose

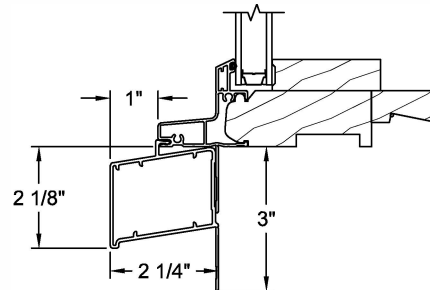

2" Sill Nose



JAMB EXTENDER OPTIONS

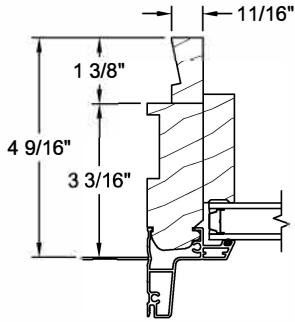

4 9/16" Jamb Width
4/4 Jamb Thickness

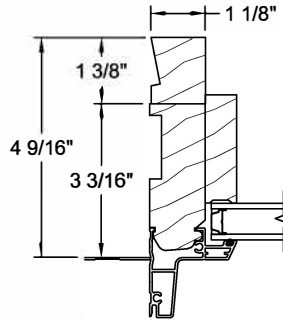

4 9/16" Jamb Width
5/4 Jamb Thickness

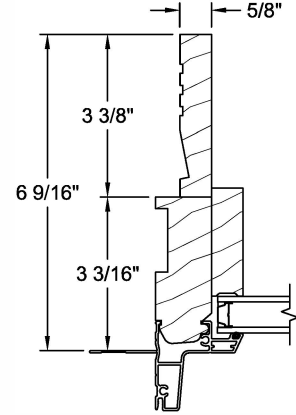

6 9/16" Jamb Width
4/4 Jamb Thickness

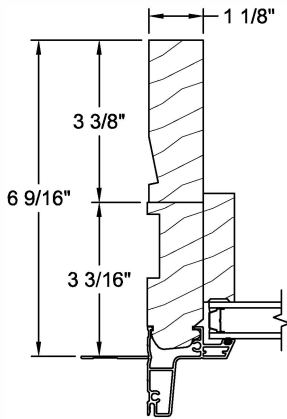

6 9/16" Jamb Width
5/4 Jamb Thickness

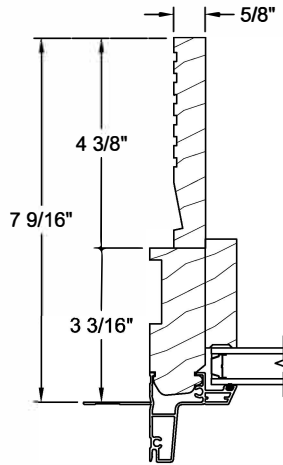

7 9/16" Jamb Width
4/4 Jamb Thickness

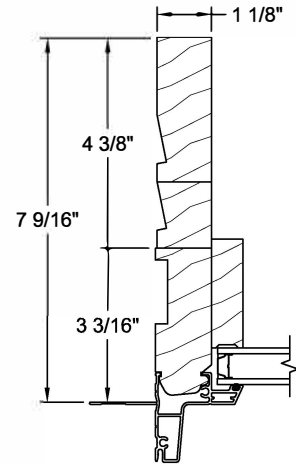

7 9/16" Jamb Width
5/4 - 5/4 Stacked Jamb



STATIONARY STRAIGHTLINE SECTIONS

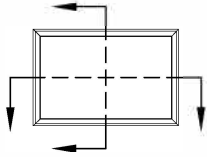

Not To Scale - Reference Only

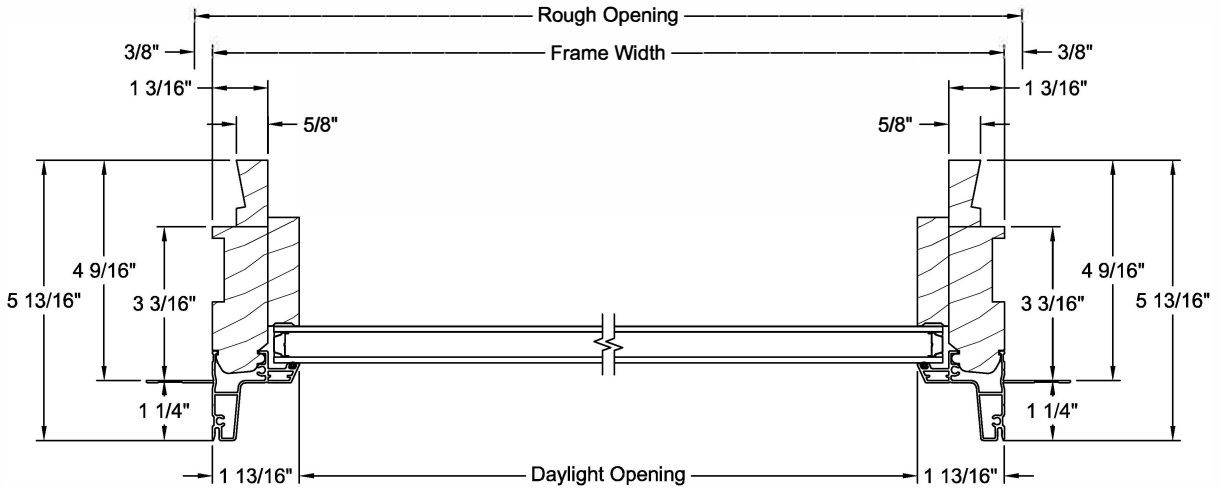
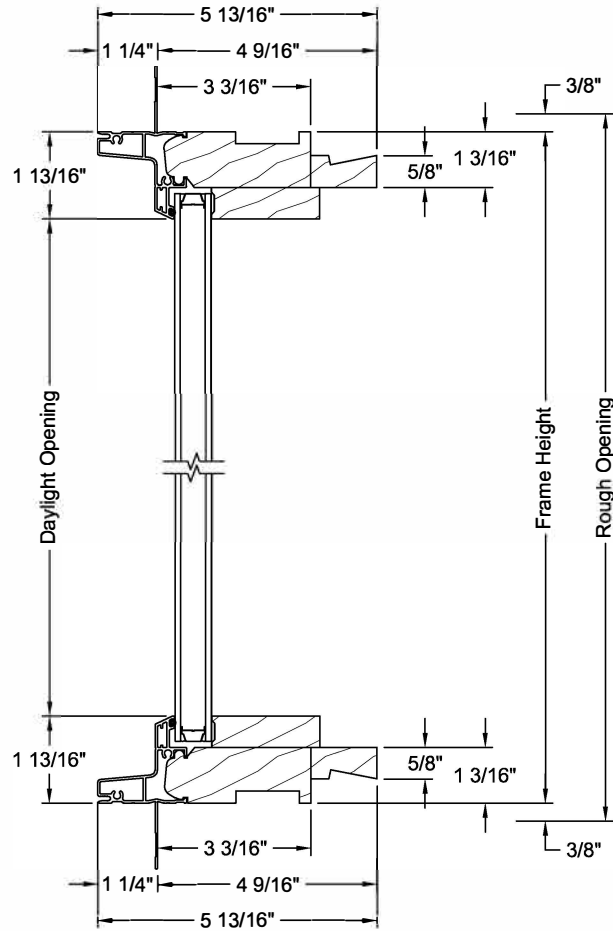



STATIONARY RADIUS-TOP SECTIONS

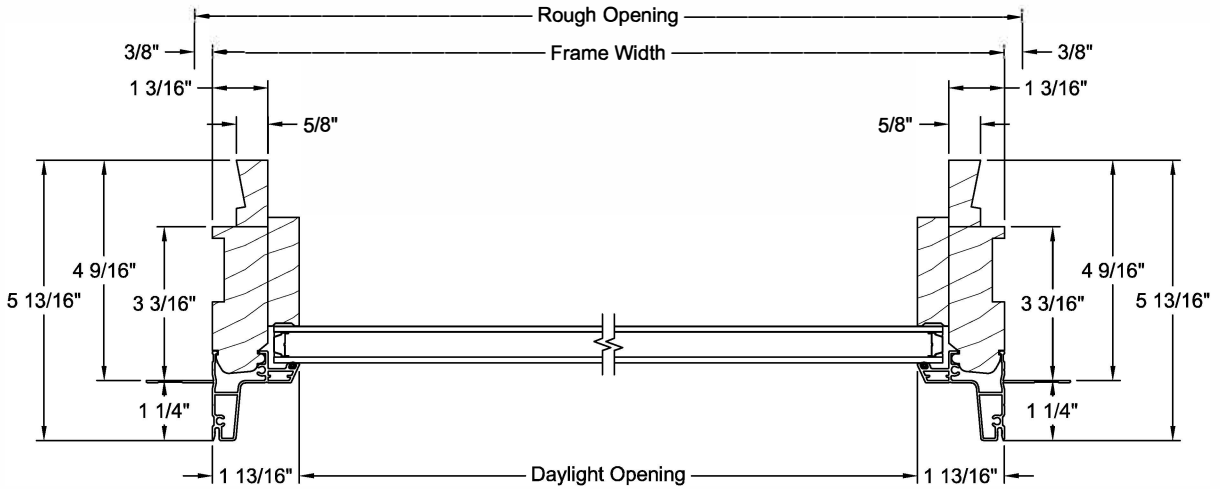
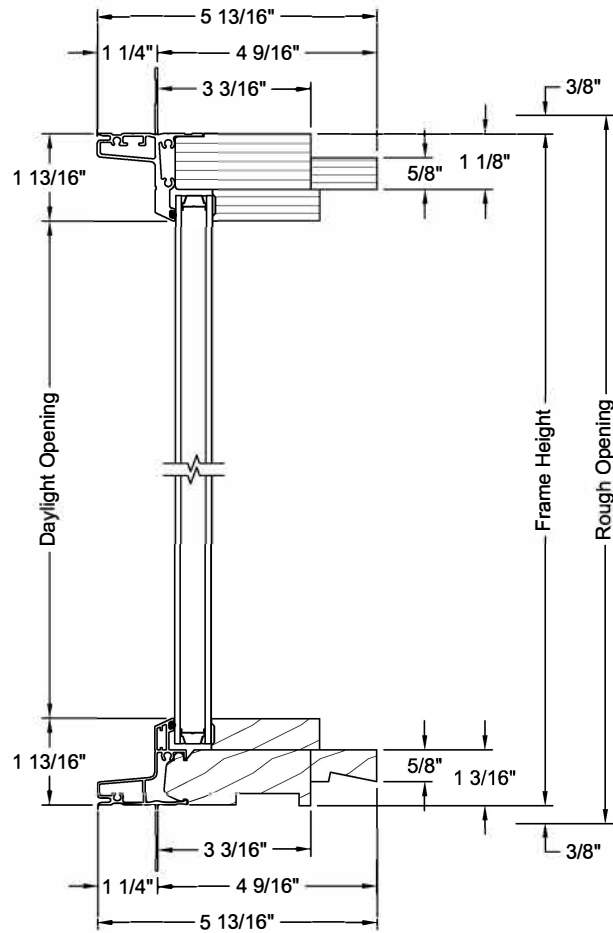
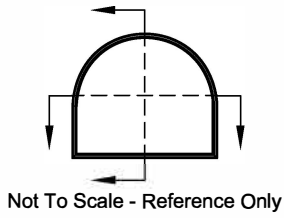



MIN-MAX STANDARD SIZING

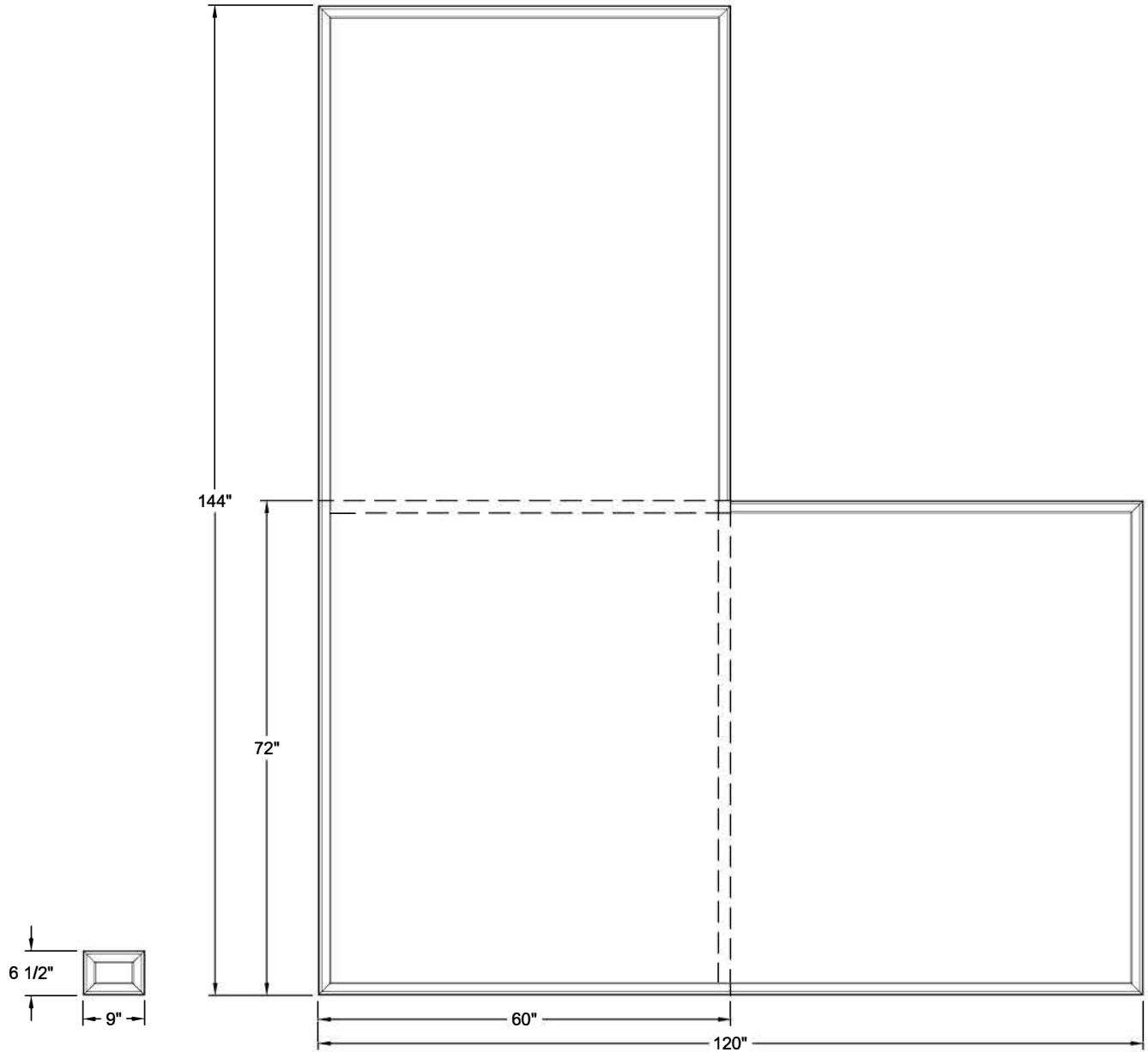

Minimum Size:
9" x 6 1/2"

with Maximum Width:
120" x 72"

with Maximum Height:
60" x 144"

Width and height combinations are limited to a maximum frame size of 60 ft².
Standard sizes are shown. Smaller or larger sizes may be available as custom orders.
Contact JELD-WEN Customer Service for more information.